

COSENTINO® PRODUCT GUIDE

# Cosentino Product Guide

SILESTONE® DEKTON® SENSA

COSENTINO®

SILESTONE® DEKTON® SENSA

An aerial night view of a city, likely Rome, showing a dense urban landscape with illuminated buildings and streets. In the foreground, a large, glowing white sign is mounted on a rooftop structure. The sign reads "COSENTINO" in a large, bold, sans-serif font, with "SURFACES" in a smaller font below it. To the right of the sign, a small red "VISA" logo is visible. The background shows a wide, multi-lane road with traffic, streetlights, and a large, classical-style building on the right side. The sky is dark with some clouds, and the overall atmosphere is that of a bustling city at night.

COSENTINO  
SURFACES

VISA

# A Big Family Around the World

## USA

Cosentino ANAHEIM  
 Cosentino ATLANTA  
 Cosentino AUSTIN  
 Cosentino BOSTON  
 Cosentino CHARLOTTE  
 Cosentino CHICAGO  
 Cosentino CINCINNATI  
 Cosentino DALLAS  
 Cosentino DENVER  
 Cosentino DETROIT  
 Cosentino FORT LAUDERDALE  
 Cosentino HAWAII  
 Cosentino HOUSTON  
 Cosentino KANSAS CITY  
 Cosentino LONG ISLAND  
 Cosentino LOS ANGELES  
 Cosentino MILWAUKEE  
 Cosentino MINNEAPOLIS  
 Cosentino NASHVILLE  
 Cosentino NEW JERSEY  
 Cosentino NEW ORLEANS  
 Cosentino ORLANDO  
 Cosentino PHILADELPHIA  
 Cosentino PHOENIX  
 Cosentino PITTSBURGH  
 Cosentino PORTLAND  
 Cosentino RALEIGH  
 Cosentino ROCHESTER  
 Cosentino SACRAMENTO  
 Cosentino ST. LOUIS  
 Cosentino SALT LAKE CITY  
 Cosentino SAN DIEGO  
 Cosentino SAN FRANCISCO  
 Cosentino SEATTLE  
 Cosentino SPOKANE  
 Cosentino TAMPA  
 Cosentino VIRGINIA  
 Cosentino WASHINGTON DC  
 Cosentino CITY LOS ANGELES  
 Cosentino CITY MANHATTAN  
 Cosentino CITY MIAMI  
 Cosentino CITY SAN FRANCISCO  
 Cosentino HUB HOUSTON  
 Cosentino HUB NORFOLK

## CANADA

Cosentino CALGARY  
 Cosentino QUEBEC  
 Cosentino TORONTO  
 Cosentino VANCOUVER  
 Cosentino CITY MONTREAL  
 Cosentino CITY TORONTO

## MEXICO

Cosentino MEXICO DF

## PUERTO RICO

Cosentino PUERTO RICO

## SPAIN

Cosentino A CORUÑA  
 Cosentino ALMERÍA  
 Cosentino BARCELONA  
 Cosentino BILBAO  
 Cosentino CASTELLÓN  
 Cosentino GIRONA  
 Cosentino GRANADA  
 Cosentino MADRID  
 Cosentino MURCIA  
 Cosentino SAN SEBASTIAN  
 Cosentino SANTANDER  
 Cosentino SEVILLA  
 Cosentino TOLEDO  
 Cosentino VALENCIA  
 Cosentino VALLADOLID  
 Cosentino VIGO  
 Cosentino ZARAGOZA  
 Cosentino CITY BARCELONA  
 Cosentino CITY MADRID

## PORTUGAL

Cosentino LISBOA  
 Cosentino PORTO

## BRAZIL

Cosentino FORTALEZA  
 Cosentino GOIÂNIA  
 Cosentino LATINA VITORIA  
 Cosentino RECIFE  
 Cosentino SANTA CATARINA  
 Cosentino SAO PAULO

## IRELAND

Cosentino DUBLIN

## UK

Cosentino BELFAST  
 Cosentino DARLINGTON  
 Cosentino EAST LONDON  
 Cosentino GLOUCESTER  
 Cosentino HODKES  
 Cosentino MANCHESTER  
 Cosentino NEWMARKET  
 Cosentino SCOTLAND  
 Cosentino CITY LONDON

## DENMARK

Cosentino DENMARK

## FINLAND

Cosentino HELSINKI

## GERMANY

Cosentino BERLIN  
 Cosentino DÜSSELDORF  
 Cosentino MÜNCHEN  
 Cosentino STUTTGART

## ITALY

Cosentino CATTOLICA  
 Cosentino LAZIO  
 Cosentino MILANO  
 Cosentino TORINO  
 Cosentino VENEZIA  
 Cosentino CITY MILANO

## FRANCE

Cosentino LYON  
 Cosentino MARSEILLE  
 Cosentino PARIS  
 Cosentino RENNES  
 Cosentino STRASBOURG  
 Cosentino TOULOUSE

## AUSTRIA

Cosentino WIEN

## BELGIUM

Cosentino BELGIUM

## MALAYSIA

Cosentino KUALA LUMPUR

## NORWAY

Cosentino OSLO

## SWEDEN

Cosentino GÖTEBORG  
 Cosentino STOCKHOLM

## SWITZERLAND

Cosentino ZÜRICH

## HOLLAND

Cosentino THE NETHERLANDS

## ISRAEL

Cosentino CAESAREA  
 Cosentino TEL AVIV

## TURKEY

Cosentino ANKARA  
 Cosentino ISTANBUL  
 Cosentino IZMIR

## SINGAPORE

Cosentino SINGAPORE  
 Cosentino CITY SINGAPORE

## AUSTRALIA

Cosentino ADELAIDE  
 Cosentino BRISBANE  
 Cosentino MELBOURNE NORTH  
 Cosentino MELBOURNE SOUTH  
 Cosentino PERTH  
 Cosentino SYDNEY  
 Cosentino CITY SYDNEY  
 Cosentino HUB SYDNEY

## NEW ZEALAND

Cosentino AUCKLAND  
 Cosentino LD CHRISTCHURCH

## JAPAN

Cosentino LD TOKIO

## SOUTH AFRICA

Cosentino JOHANNESBURG  
 Cosentino LD CAPE TOWN

## UAE

Cosentino LD DUBAI  
 Cosentino CITY DUBAI

## POLAND

Cosentino WARSAW



# Content

<b>Cosentino</b>	
Mission	9
Vision	11
<b>Silestone® Quartz Surfaces</b>	13
News	14
Eternal Noir	14
Loft Series	15
Benefits	16
RAW Finish	17
Suede Finish	18
N-Boost	19
Formats	20
Textures	21
Edges	23
Applications	26
Kitchens Countertops	26
Integrity Sinks	28
Bathrooms Countertops	30
Cladding	31
Flooring	31
Bathroom Sinks	32
Shower Trays	33
Color Chart	34
Color Groups	37
<b>Dekton® Ultracompact Surfaces</b>	38
News	40
New Xgloss Stonika	40
New Industrial Collection Colors	42
New Portum - Natural Collection	43
Dekton® Slim 4mm	44
Dekton® Slim 4mm Bathroom	46
Advantages	48
Warranty	48
Formats	48
Applications	50
Kitchen Countertops	50
Outdoor Kitchen Countertops	53
Bathroom Countertops and Wall Covering	54
Façades	56
Flooring Solutions	58
Aura Bookmatch	59
Color Chart	60
Color Groups	62
<b>Sensa by Cosentino® Protected Natural Stone</b>	64
Advantages	66
Color Chart	70
<b>Scalea® Natural Stone</b>	74
Color Chart	76
<b>Prexury</b>	80
Color Chart	80
<b>Distributor Locations North America</b>	82

# Mission

*To be the leading company that, together with our clients, responsibly imagines and anticipates high value, innovative surfaces for the world of architecture and design.*

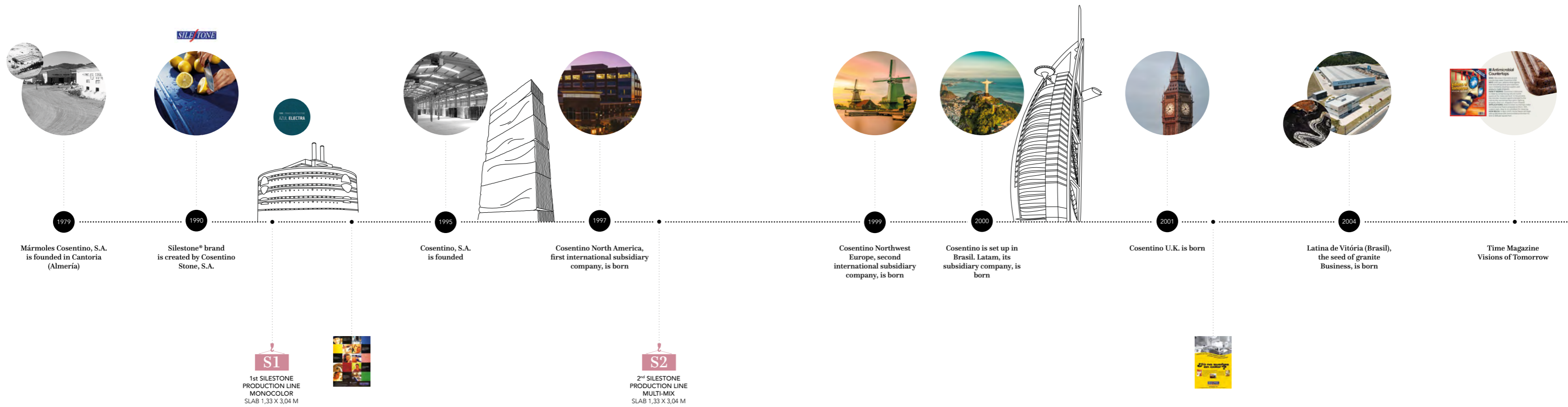

# Vision

To be the global leader in the surfaces market via our brands, offering innovative architectural solutions that provide design, value and inspiration to our clients' lives.

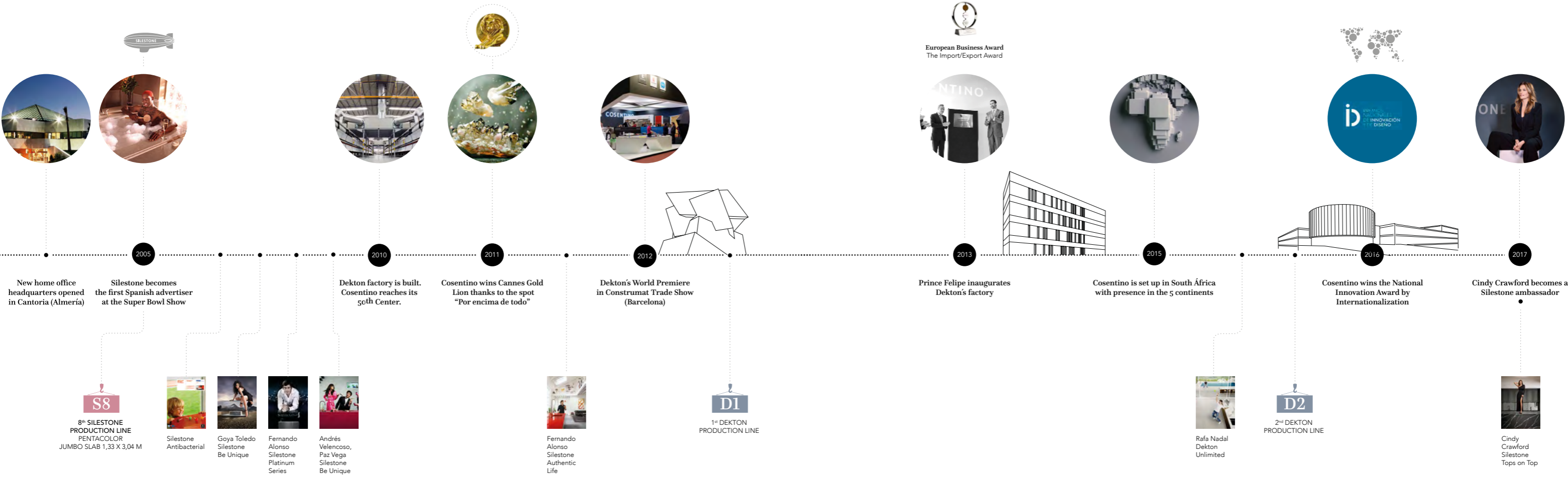



SILESTONE®

## Quartz Surfaces

*Silestone presents extreme durability in kitchen and bathroom and other spaces where traffic and daily use is high. Enjoy the endless colors possibilities.*

The advantages of Silestone are numerous. Silestone is low maintenance and has a high resistance to stains and scratches, as well as a low liquid absorption rate. Silestone's nearly indestructible surface is stain, scorch and scratch resistant. With a very low absorption index and a minimal number of joints, Silestone is perfect for spaces where liquid exists.

Silestone is resistant and continues to be enjoyed over time, going beyond the surface. It is manufactured in more than 100 colors, three textures and various formats, making it highly versatile. Colors range from muted tones that are generally associated with natural stone to vibrant colors that are not found in nature.

Silestone's color uniformity and consistency allows for an unlimited number of edge details including but not limited to: bevel, ogee, bullnose and waterfall. It is also malleable enough to be used in large pieces without requiring joints. Silestone is the perfect choice for kitchen, bathroom, flooring, cladding and unlimited applications.

### Certifications



Silestone® Eternal Emperador  
Eternal Collection

SILESTONE®

## Product News

*Silestone is continuously reinventing itself and following new trends on colors and applications.*



**New**

## Silestone® Eternal Collection

*featuring  
Eternal Noir*

The Silestone Eternal Collection is a series of new colors inspired by some of the most desired exotic stones with a reputation for being beautiful and timeless.

Today, marble-looks are making a statement not only in the world of architecture and design with surfacing, but also in industries such as fashion and home accessories.



Silestone®  
Eternal Noir

## New Loft Series

*Pure Urban Style*

Loft Series is a new collection by Silestone® whose inspiration comes straight from the industrial look that emerged in the 50s in the USA. The new Colors in the Loft Series are unadorned. They are textured to highlight the character of the space, of the beauty of the apparent imperfections of cement and concrete.

Silver Lake and Brooklyn were designed to create ambiances that are steely and sophisticated but, above all, honest. This series also comes with a new Silestone® texture called Raw, in keeping with the industrial look of the new collection. Raw Texture gives the feel and look found in building materials, combining surface relief with a matte finish.

Discover these new colors and textures. You'll love the new Loft ideas.

1



2



1 Brooklyn 2 Silver Lake



SILESTONE®

## Benefits

Silestone® is made out of Natural Quartz created to provide color and texture for bath and kitchen surfaces. Thanks to its physical and chemical properties, a result of years of investigation, it guarantees maximum safety and hygiene.



### Resistance to Stains

Silestone® is a non-porous surface which is highly resistant to stains from coffee, wine, lemon juice, oil, vinegar, make-up and many other daily-use products.

### Resistant to Scratching

Quartz is one of the hardest minerals that exists. This makes our products very durable, with a high level of resistance to external damage.

### Resistant to Impacts

Silestone® high level of resistance to impacts allows very hard objects (pots, trays, etc.) to be handled with total ease.

New

## Silestone® Raw Texture

*Following the industrial trend comes the new raw texture.*

This surface reflect the beauty of imperfections and irregularities of cement.

The shape and surface texture, in addition to exclusive and unique designsm represents the naturalness of this material with the best properties of Silestone®.



Impact Resistant



Stain Resistant



Scratch Resistant



Acid Resistant



# Suede

## The Soft Velvety Texture

Discover the soft velvety texture of Silestone®  
Feel the sensation over your countertop.

Same Resistance. Best touch Ever.

\*Check availability on Silestone® colors with N-Boost

## N-Boost Technology by Silestone®

The hydro-repellent properties of N-BOOST prevents the clinging of common liquids in kitchen and bathroom spaces. This is specially useful when liquids remain on the surface for hours: with N-BOOST preventing them from binding to the surfaces. Thanks to N-BOOST, cleaning is much simpler.



Easy Clean

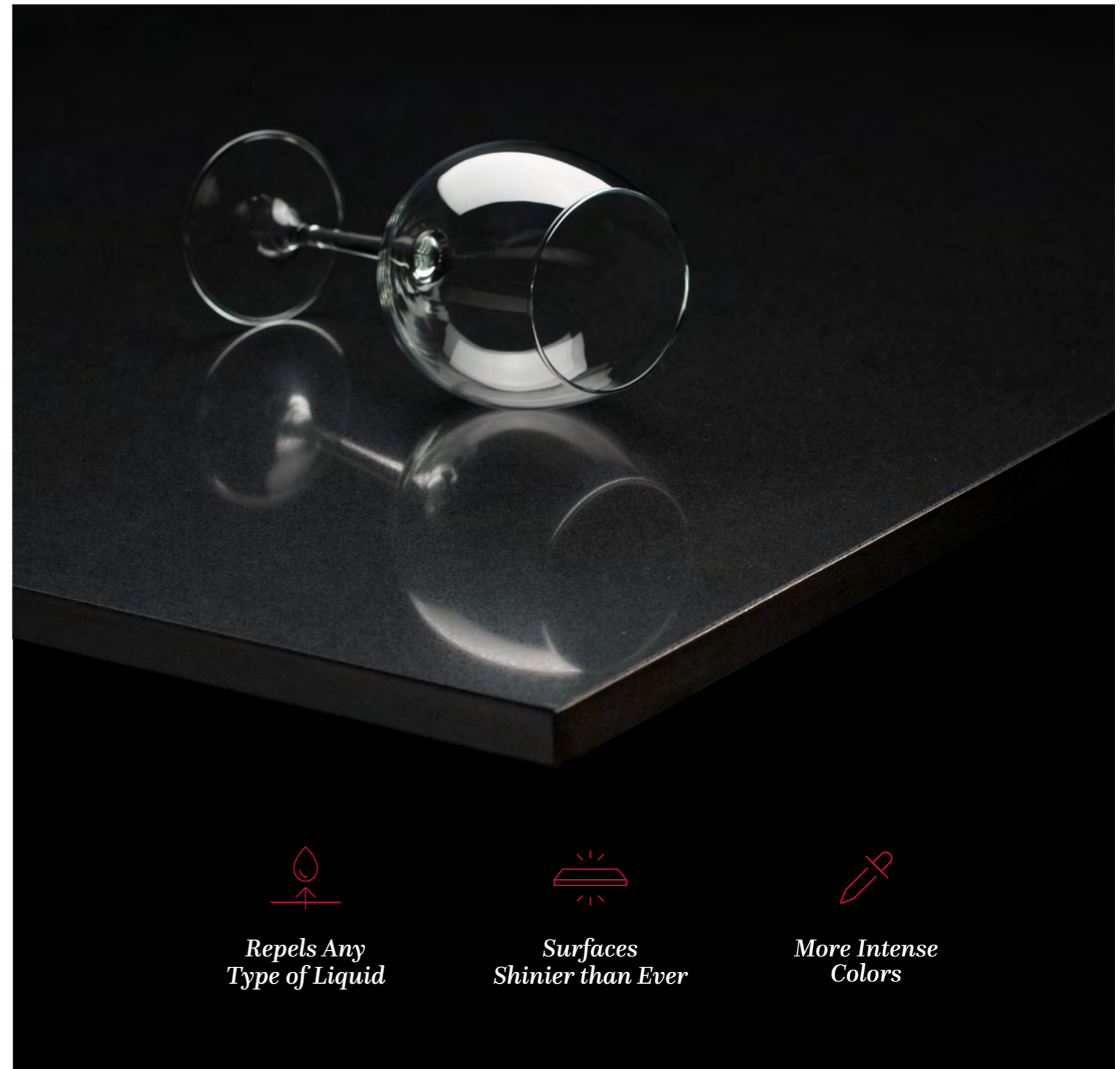

Repels Any Type of Liquid

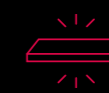

Surfaces Shinier than Ever



More Intense Colors

SILESTONE®

## Available Tile and Slab Sizes

Silestone colors are available in regular slabs\* 55"x120" and Jumbo slabs up to 63"x128". Silestone is available in the following tile formats: 12"x12", 24"x12", 24"x16", 16"x16", 24"x24" and 36"x12"

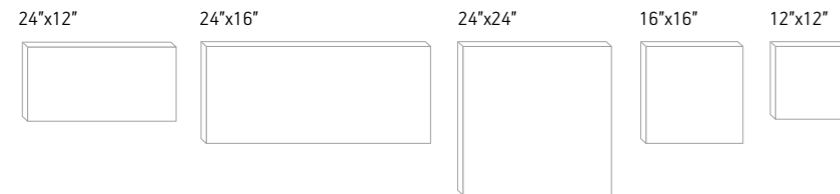
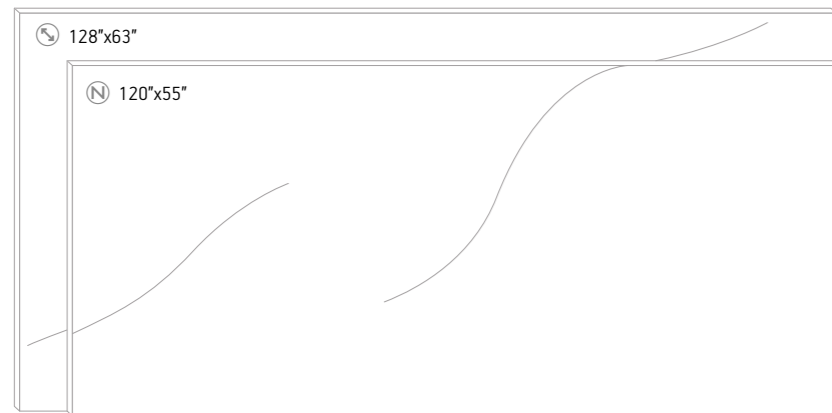

SILESTONE®

## Thicknesses

Silestone® slabs are sold in thicknesses of 1.2, 2 and 3cm. Different pieces can also be combined to create thicker edges.

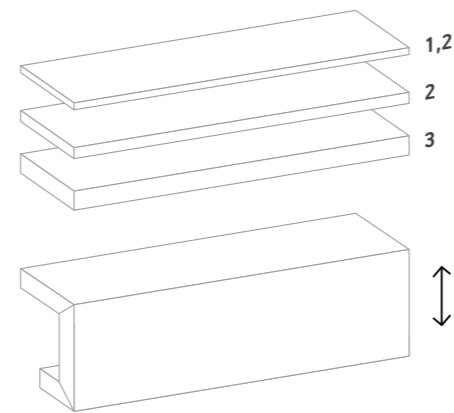

\*Measurements given in centimetres

SILESTONE®

## Textures

With the aim of being adapted to your style, Silestone offers you different textures to any of your chosen applications. Polish, Suede or Volcano are three possibilities that make your imagination fly and have your countertop, flooring or cladding with the texture that you have always wanted.

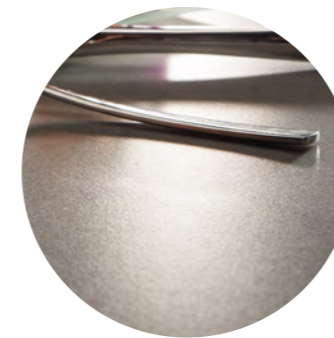

### Suede

The Suede or matt finish, recently improved by Silestone® offers a flat, non-rugged feel that provides a unique look and feel on account of its beauty and elegance.



### Volcano

Volcano is a rustic texture, rough to the touch while also being smooth. It is the result of research into how to create a rugged surface that is both attractive and pleasant to the touch for use in kitchens and bathrooms.



### Polished

All the colors of Silestone® and ECO Line Color Series are available in this texture that is smooth to the touch as well as having a consistent, intense, and uniform color.



### Raw

Following the industrial trend comes the new Raw texture, this surface reflects the imperfections and irregularities of cement. The shape and surface texture, in addition to exclusive and unique design, represent the naturalness of this material with the best properties of Silestone.

### Jumbo Size

Cosentino® is one of the few manufactures to offer quartz slabs in Jumbo format (maximum 63x128"). This format allows the creation of large surfaces with a minimum number of joints. It allows versatility of design and greater hygiene. It allows the manufacture of large islands in just one piece. This way, we optimize the use of the slab and reduce wastae.

\*Check available slab format with your local center.



Silestone® Silver Lake  
New Loft Series

SILESTONE®

## Edges

Customized cutting and polishing processes can be used for Silestone®, creating edges of all types. This section details some of the most popular ones requested by our customers, but the combinations are limitless.

### Edges 2 cm



Bullnose



Demi Bullnose



Ogee



Basic / Eased

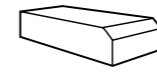

Bevel Xmm



Top Roundover



Shark Nose



Shark Nose

### Edges 3 Cm



Bullnose



Demi-Bullnose

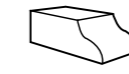

Ogee

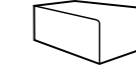

Basic / Eased

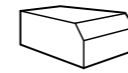

Bevel Xmm

### Edges 4 cm



Bullnose



Demi Bullnose



Ogee



Basic / Eased

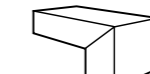

Mitered

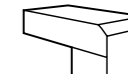

Bevel Xmm



Waterfall



Ogee Bullnose

### Other Edges

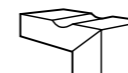

Edge 45° + Mitred  
bevelled  
edge 45%

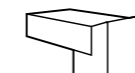

45% Bevelled edge

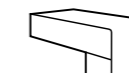

Polished straight edge  
+ Non-bevelled planed  
section



1/4 Bullnose and  
Non-bevelled planed  
section



1/2 Bullnose and  
non-bevelled planed  
section

 SILESTONE®

# TOPS ON TOP

Cindy Crawford on Silestone Eternal Calacatta Gold



SILESTONE®

## Applications

*Thanks to its remarkable characteristics, Silestone is the ideal surface choice for unlimited applications.*

## Kitchen Countertops

Silestone is the only quartz surface with a 25 year transferable warranty. It also offers a wide range of colors and textures to transform your kitchen into a unique space. Silestone can be used in a variety of applications, including countertops, flooring, cladding and backsplashes or even furniture.

*“The Kitchen is the heart of the Home”*



Silestone® Blanco Orion

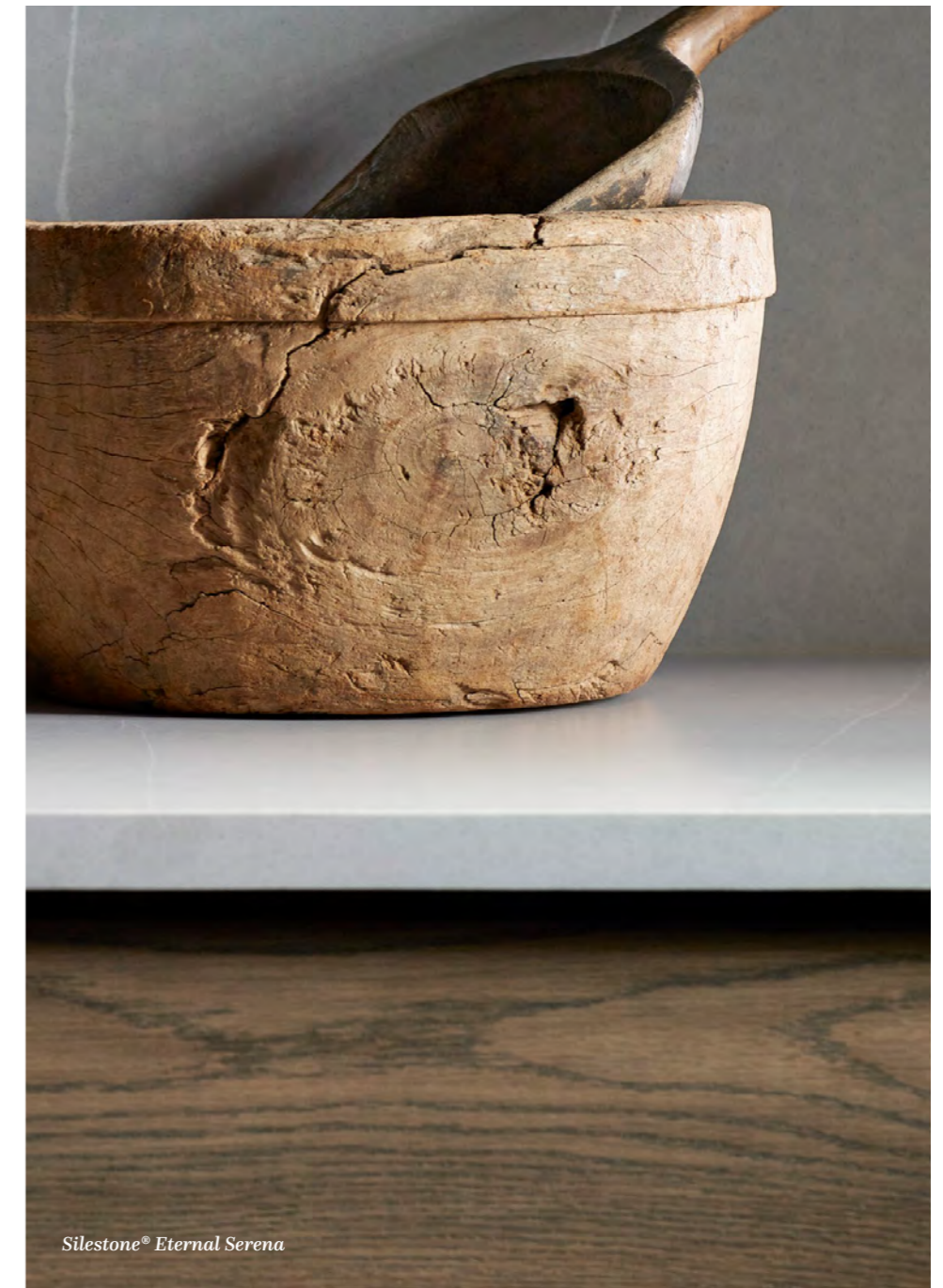

Silestone® Eternal Serena

# Integrity Sinks

No pieces, no creases, no limits. Integrity wants your kitchen to be whole; a place where there is no start or finish. Integrity gives you the sensation of unity, of perfect integration with the rest of the elements of your countertop.

**New**

**Integrity Q**  
Elements and details to create a unique kitchen.

Silestone® by Cosentino, has developed the new minimalist kitchen sink, Integrity Q, designed for those who seek elements and details that combine perfectly to create a unique kitchen with personality.

With an almost square shape, the Q model from the Integrity by Silestone® kitchen sink range is the perfect choice for those who love geometry.



Silestone® Calacatta Gold  
Integrity Q

## Colors\*

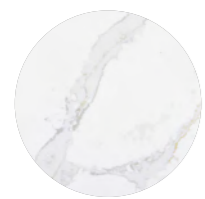

ETERNAL CALACATTA GOLD

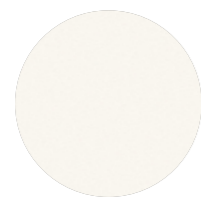

WHITE ZEUS EXTREME



LAGOON

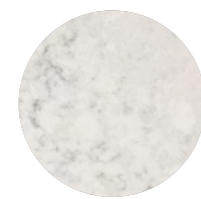

HELIX



LYRA

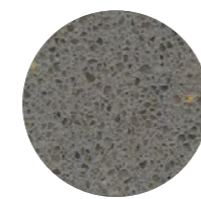

GREY EXPO

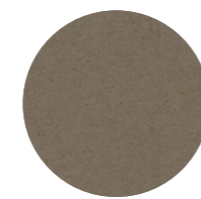

UNSUI

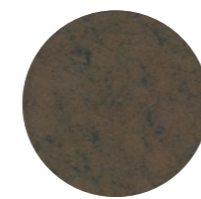

GREY AMAZON

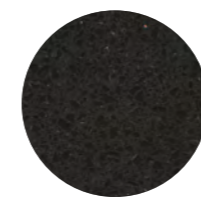

STELLAR NIGHT

\*Rest of Integrity colors available on request.

### Integrity DUE SMALL & LARGE

*In one single piece*

Integrity Due Small and Integrity Due Large are the models that embodies Integrity's concept. Size for Due S is 13 3/8" x 14 1/2" x 6 7/8" and size for Due Large is 20" x 14 1/2" x 6 7/8". These are the perfect choices for those who love curved shapes.

### Integrity TOP



20" x 14 1/2" x 6 7/8"

### Integrity Due Large



20" x 14 1/2" x 6 7/8"

### Integrity DUE XL

*Straight Lines. Total Integration*

DUE XL dimensions 26 3/8" x 17 1/8" x 8 17/64" are ideal for any kitchen space, it is characterized by its straight lines. The perfect choice for those who see the simplicity of straight lines as the mark of style and beauty.

### Integrity Due Small



13 3/8" x 14 1/2" x 6 7/8"

### Integrity DUE XL



26 3/8" x 17 1/8" x 8 17/64"

### Integrity Q



20 1/16" X 16 1/8"

## Bathroom Countertops

*Bathroom Collection by Cosentino is an unique concept in the architectural sector based on the use of single materiales that offer superior performance and remarkable beauty. Silestone is a surface made with quartz available in more than 70 exclusive colors.*

Silestone possesses the ideal characteristics for bathroom countertops. With a low absorption level and virtually no joints, the bathroom surface will remain unchanged after its daily use.



## Bathroom Cladding

Bathrooms are personal spaces where one should feel relaxed and refreshed. There's no reason these areas should be drab or feature less design!

Silestone reinvents the traditional design of the bathroom space with custom-made large format panels. It can be installed vertically as wall cladding or horizontally as flooring. This customization eliminates joints and creates visual continuity.



## Bathroom Flooring

Bathrooms are a high traffic area and the durability and resistance of Silestone reduces wear on bathroom floors. Its minimal maintenance requirements and low porosity make it the ideal product for rooms in which water and other personal hygiene products are used. Environments with damp conditions or changes in temperature require flooring that offers outstanding performance. Silestone not only meets these requirements, it exceeds them with the added benefit of attractive design.





## Bathroom Sinks



Silestone Sinks are built with a unique and innovative design for flexibility and elegance.

Armony 





Balance 



Simplicity  



Equilibrium  



Basic 



Elegance 





Nova  



Symmetry 



Reflection  



Silence  



Exclusive 



## Bathroom Shower Trays

The Silestone shower tray collection is based on an exclusive design that offers flexibility and safety. Your shower tray can be adapted to your space.

Freccia



Bubbles



Doppio



Kador



Kador Suite



Exelis



SILESTONE®

# Color Chart

More than 60 colors in different textures. Find your favorite.

- ✦ POLISHED
- ☉ SUEDE
- ☼ VOLCANO
- ☼ RAW

- Ⓝ REGULAR SIZE
- Ⓜ JUMBO SIZE
- Ⓝ N-BOOST
- Ⓝ INTEGRITY SINK

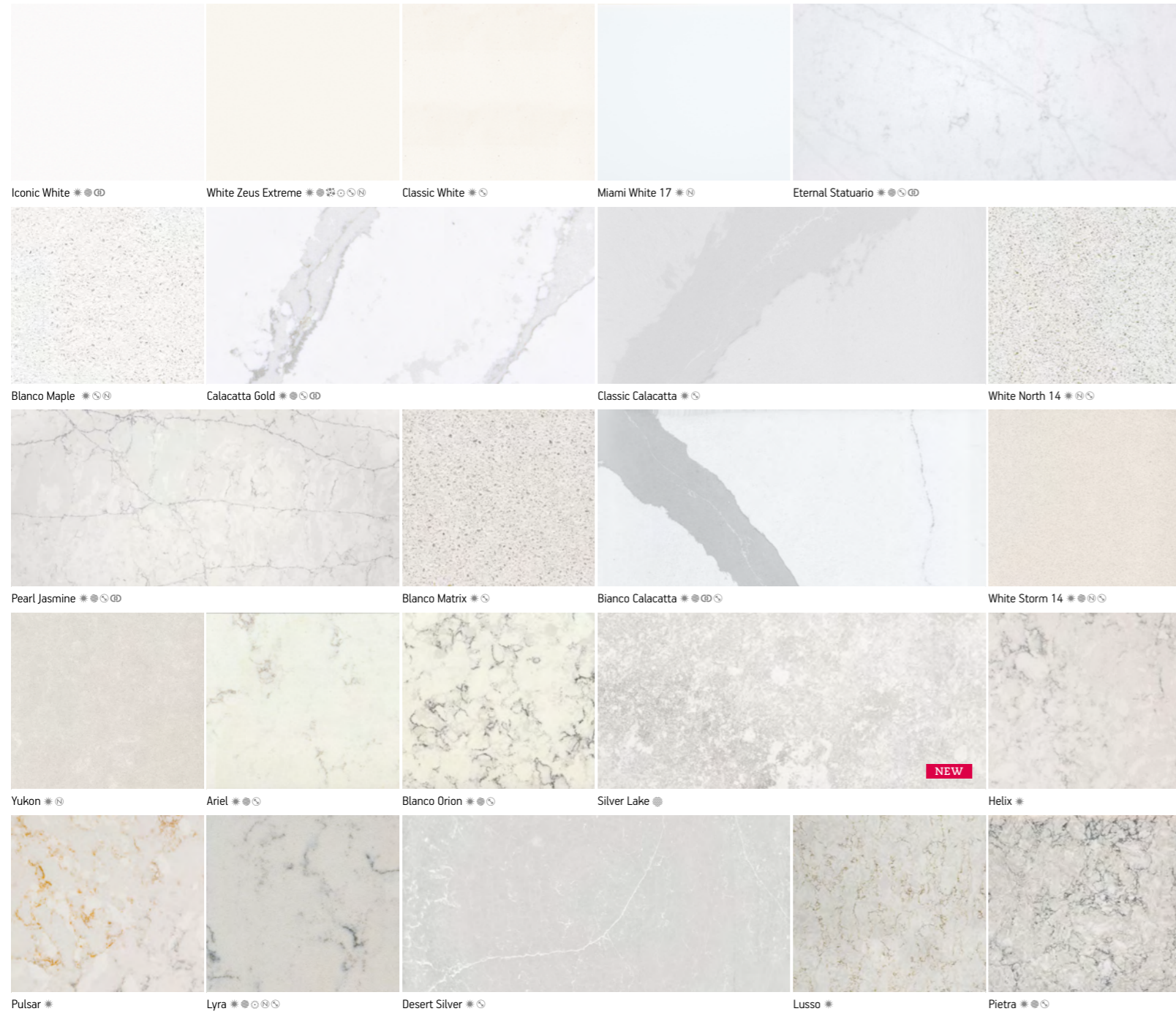

SILESTONE®

# Color Chart

- ☀ POLISHED
- ☁ SUEDE
- ☄ VOLCANO
- ☄ RAW

- Ⓝ REGULAR SIZE
- Ⓜ JUMBO SIZE
- Ⓝ N-BOOST
- ⊕ INTEGRITY SINK

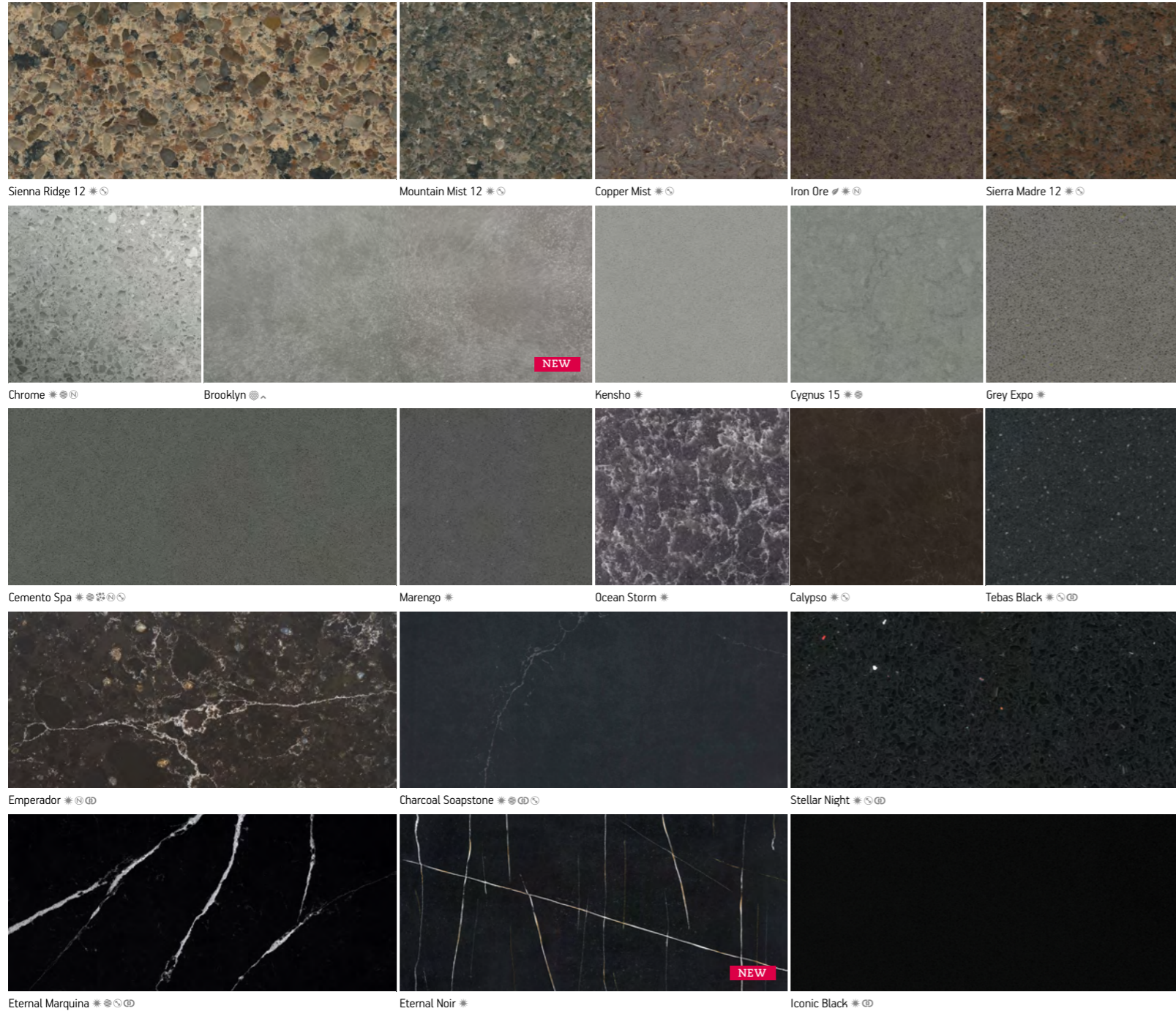

SILESTONE®

# Quartz Surfaces - Available Colors

	COLOR NAME	FINISH	N-BOOST		COLOR NAME	FINISH	N-BOOST
GROUP 1	BLANCO CITY	POLISH	–	GROUP 4	BAMBOO 08	POLISH	–
	GREY EXPO	POLISH	–		BLANCO ORION*	POLISH	–
	LENA	POLISH / SUEDE	–		CHARCOAL SOAPSTONE	POLISH / SUEDE	Ⓝ
	MARENGO	POLISH	Ⓝ		COPPER MIST	POLISH	–
	MIAMI WHITE 17	POLISH	–		FOREST SNOW	POLISH	–
	NOKA*	POLISH	–		ICONIC BLACK	POLISH	Ⓝ
	TEBAS BLACK 18	POLISH	Ⓝ		KENSHO	POLISH	–
GROUP 2	ALTAIR 15*	POLISH / SUEDE	–	LAGOON*	POLISH / SUEDE	–	
	BLUE SAHARA 12 (AZUL UGARIT 12)	POLISH	–	LUSO	POLISH	–	
	CAPRI LIMESTONE (BLANCO CAPRI)	POLISH	–	LYRA*	POLISH / SUEDE	–	
	CEMENTO SPA	POLISH / SUEDE	–	PEARL JASMINE	POLISH / SUEDE	Ⓝ	
	CORAL CLAY	POLISH / SUEDE	–	STELLAR NIGHT	POLISH	Ⓝ	
	CYGNUS 15*	POLISH / SUEDE	–	STELLAR SNOW 13	POLISH	–	
	HELIX	POLISH	–	VORTIUM	POLISH	–	
	IRON BARK	POLISH / SUEDE	–	WHITE ZEUS EXTREME	POLISH / SUEDE	–	
	PULSAR	POLISH	–	GROUP 5	BROOKLYN <b>NEW!</b>	RAW–	–
	ROYAL REEF	POLISH / SUEDE	–		CALYPSO	POLISH	–
WHITE NORTH 14	POLISH	–	CHROME		POLISH	–	
WHITE STORM 14	POLISH / SUEDE	–	ETERNAL EMPERADOR		POLISH	Ⓝ	
ALPINA WHITE 08	POLISH	–	ETERNAL MARFIL		POLISH / SUEDE	Ⓝ	
ARIEL	POLISH	–	ETERNAL SERENA		POLISH / SUEDE	Ⓝ	
BLANCO MAPLE 14	POLISH	–	ETERNAL STATUARIO		POLISH / SUEDE	Ⓝ	
DESERT SILVER	POLISH / SUEDE	Ⓝ	ICONIC WHITE*		POLISH / SUEDE	Ⓝ	
IRON ORE	POLISH	–	KIMBLER MIST		POLISH	–	
MOUNTAIN MIST 12	POLISH	–	LUNA 14		POLISH	–	
GROUP 3	SIENNA RIDGE 12	POLISH	–	OCEAN JASPER	POLISH	–	
	TIGRIS SAND	POLISH	–	OCEAN STORM	POLISH	–	
	UNSUI	POLISH	–	PACIFIC	POLISH	–	
	YUKON	POLISH	–	PIETRA	POLISH / SUEDE	–	
				QUASAR	POLISH	–	
				SILVER LAKE <b>NEW!</b>	RAW–	–	
				WHITE PLATINUM	POLISH	–	
			GROUP 6	BIANCO CALACATTA	POLISH	Ⓝ	
				CLASSIC CALACATTA	POLISH / SUEDE	Ⓝ	
				ETERNAL CALCATTA GOLD	POLISH / SUEDE	Ⓝ	
				ETERNAL MARQUINA	POLISH / SUEDE	Ⓝ	
				ETERNAL NOIR <b>NEW!</b>	POLISH	Ⓝ	
			RIVERBED	POLISH	–		
			WHITE DIAMOND	POLISH	–		

## References

- Ⓝ Available in Regular Size (up to 55" x 120")
- Ⓜ Available in Jumbo size (up to 63" x 128")
- 1.2 1.2 Cm Stock
- ☁ Suede™ Finish
- ☄ Volcano Finish
- ⊗ Special Order
- ☄ Raw Finish
- ⊗ No Longer in Production (Available only while supplies last)
- Ⓝ Colors with N-Boost Property

STANDARD SIZE: 55" x 120"  
 JUMBO SIZE: 63" x 128"  
 THICKNESS: 3 cm / 2 cm / 1.2 cm  
 TILES FORMATS: 12"x12", 16"x16", 24"x12", 24"x16", 24"x24"  
 FOR 1.2cm AVAILABILITY PLEASE CONTACT YOUR COSENTINO CENTER  
 FOR 1.2CM NON STOCK COLORS CHECK AVAILABILITY AS  
 SPECIAL ORDER WITH EXTENDED LEAD TIMES.  
 DIMENSIONS (inches)  
 SUEDE available in same sizes as Polished  
 VOLCANO only available in Regular size  
 VOLCANO can be requested in Jumbo size with minimum order of 40 slabs

Please ask for availability of other colors:  
 SUEDE: minimum order 20 slabs  
 VOLCANO: minimum order 40 slabs



DEKTON®

## Ultracompact Surfaces

Dekton® is a sophisticated mixture of the prime materials used to manufacture glass, modern porcelain, and quartz surfaces, employing an exclusive technological process called Sinterized Particle Technology, which involves an accelerated version of the metamorphic changes that natural stone undergoes when exposed to high pressure and temperature over thousands of years.

*Dekton® uses a 25,000-tons press that turns the panel into a large-format highly resistant ultracompact surface.*

Thanks to the manufacturing technology Dekton® employs, you can get colors and textures of varying features, including highly pure and chromatically homogeneous solids, materials with very natural veins and movements, or more daring ranges of colors for any table or furniture.

### Certifications



Dekton® Taga  
Stonika Collection

DEKTON®

## Product News

*Dekton is always reinventing itself*

New

## When Dekton becomes Nature.

NEW XGLOSS  
STONIKA COLLECTION

Dekton's Industrial series was created to pay tribute to the beautiful imperfections of the metals and stone in all their different stages of ageing.

Organic processes that are reflected in the richness and complexity of oxidation and the authentic beauty of maturing stone. Dekton's unparalleled technology gives us the tools to explore and design outside the box and the result is a series of colours that celebrates these incredible materials.

Manufactured for living.

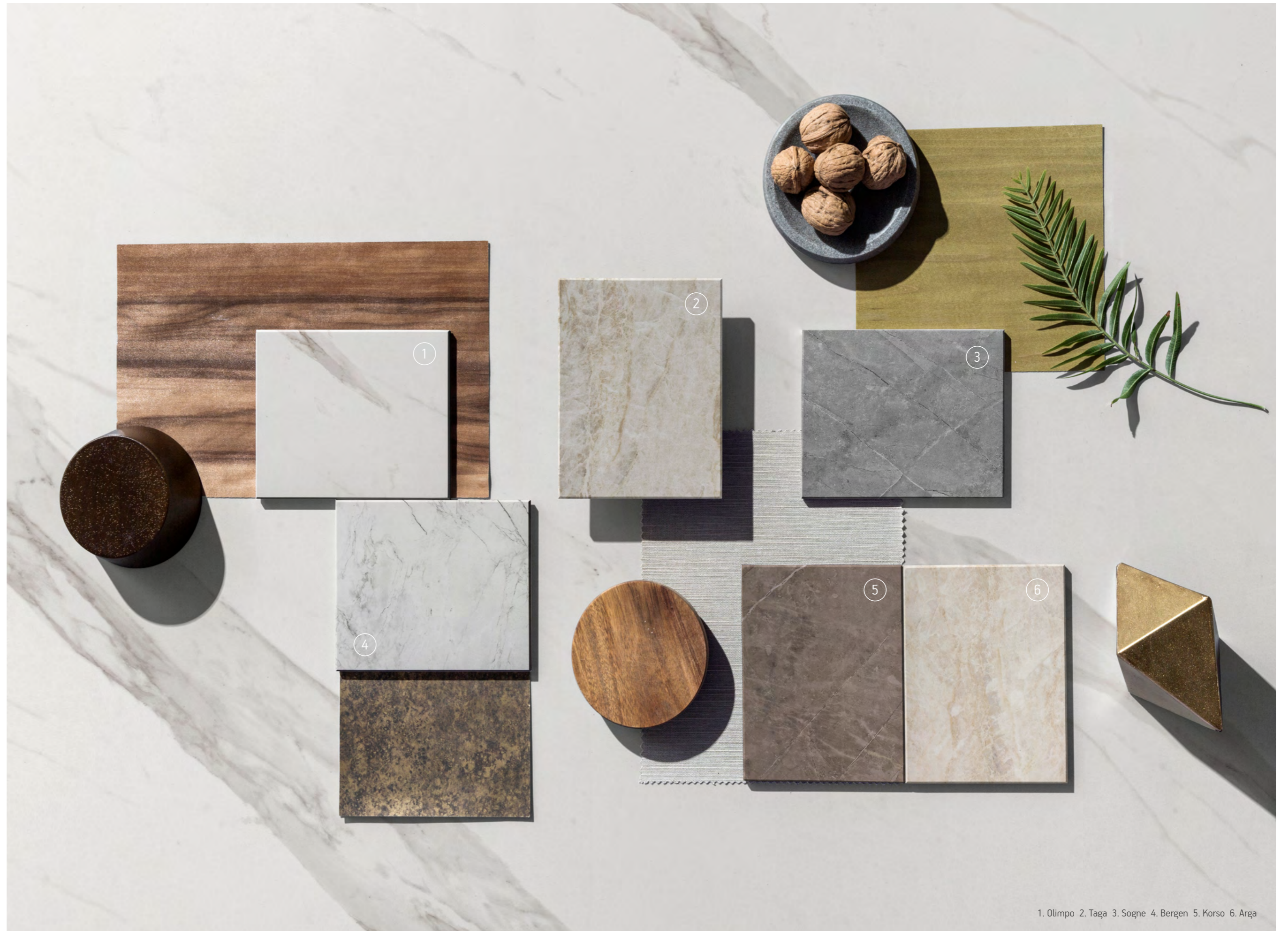

1. Olimpo 2. Taga 3. Sogne 4. Bergen 5. Korso 6. Arga



New

# Industrial Collection

Dekton® Soke  
Industrial Collection

## Dekton Laos New Industrial Collection

With its dark colors and its worn structure, it reflects the personality of the industrial design range by reinterpreting it and showing its most innovative and trendy side. Aesthetically pleasing thanks to its grey veining and warm shades, it is combined with a smooth matte finish that makes it ideal for today's most contemporary spaces.

## Dekton Lunar New Industrial Collection

A reinterpretation of conventional cement inspired by industrial aesthetics. Its subtle structure over a white base tone make Lunar a trendy color. The pattern and background merge perfectly.

## Dekton Soke New Industrial Collection

Inspired by classic cement floors, the pattern and colors have been meticulously designed. Its structure of realistic veining combines with a background filled with details. Foreground and background merge perfectly thanks to a range of grays, making it a versatile color that adapts to any application.



New

# Dekton Natural Collection featuring Portum

Portum is inspired by Portobello natural Stone, Portum, with Velvet finishes, search the perfection in tone, structure and background. The beauty of its grayish veins with sculptural pattern over a whitish base with caring watermarks. A trendy design full of character and elegance.

Portum - Natural Collection



# Dekton Natural Collection featuring Vera

Inspired by the well-known Gris Pulpis, is a color with brushstrokes of natural stone and cement. Its veined structure and cement-like base make Vera a fusion of the natural and industrial, putting the most elegant elements of both on display.

Vera - Natural Collection



NEW  
**DEKTON® SLIM**  
 designed by COSENTINO



NEW Ultra-Thin **+** Large Format & Proven Performance

-   
 Ultra Thin
-   
 Large Format
-   
 Stain Resistance
-   
 Heat Resistance
-   
 Scratch Resistance

**New**

# Dekton Slim 4 mm

*Presenting Dekton® Slim, the new, large format surface with an ultra-thin 4-mm thickness that offers unlimited design options and incredible ease of installation and transport.*



**Bathroom Cladding**

*Maximum resistance against humidity with minimal joints.*

Ideal for bathrooms, Dekton® Slim offers cladding that is ultra-resistant to humidity and stains. A highperforming product that does not require any more maintenance beyond a damp cloth.

Its large format measures 126" x 56" covers large surfaces, avoiding a large number of joints and in turn, less dirt.



**Kitchen Cladding**

*Reduced thickness, infinite possibilities*

The ultra-thin Dekton® Slim surface, with a thickness of 4 mm, is ideal for the cladding of kitchen walls and cabinets, in a harmonious blend of countertops of different thicknesses. Dekton® Slim is scratch resistant, fire-resistant and stain resistant, just like its other formats.



**Furniture Cladding**

*Transforms your home furniture with beautiful, highly resistant surfaces*

Dekton® Slim creates furniture with unprecedented performance: tables that are resistant to everything and doors that neither scratch nor stain. The size possibilities are endless since it is cut to size and easy to install.

New

## Four Reasons to Choose Dekton® Slim for your Bathroom

### Maximum resistance with minimal joints.

Ideal for bathrooms, Dekton® Slim offers cladding that is ultra-resistant to humidity and stains. A highperforming product that does not require any more maintenance beyond a damp cloth.

Its large format measures 126" x 56" covers large surfaces, avoiding a large number of joints and in turn, less dirt.

### LARGE FORMAT WITH MINIMAL JOINTS

Its large format measures 126" x 56" covers large surfaces, avoiding a large number of joints and in turn, less dirt.

### MAXIMUM RESISTANCE AGAINST HUMIDITY IN THE LIGHT WEIGHT DEKTON® FORMAT.

Dekton® Slim offers cladding that is ultra-resistant to humidity and stains, ideal for bathrooms. A highperforming product that does not require any more maintenance beyond a damp cloth.

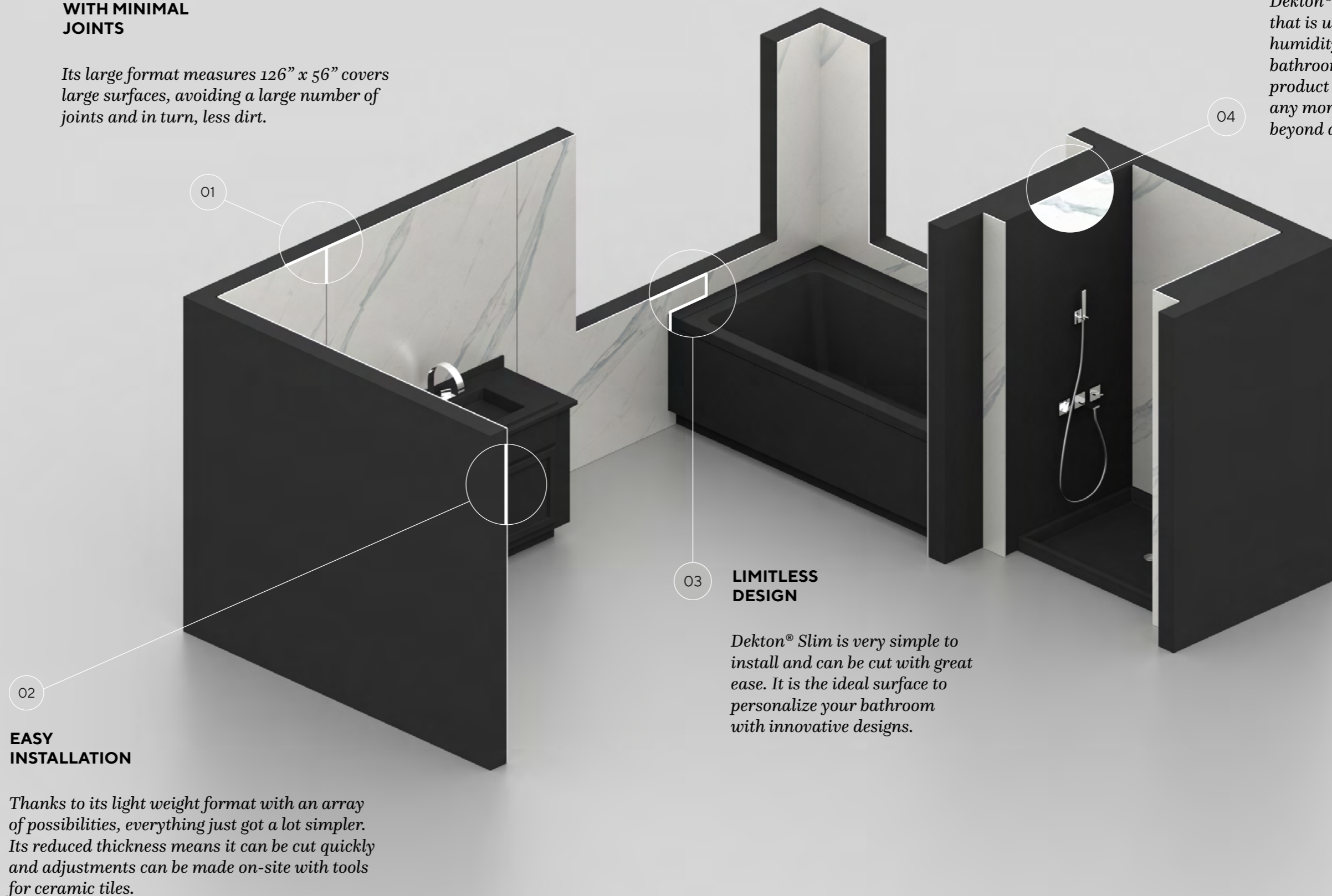

02

### EASY INSTALLATION

Thanks to its light weight format with an array of possibilities, everything just got a lot simpler. Its reduced thickness means it can be cut quickly and adjustments can be made on-site with tools for ceramic tiles.

03

### LIMITLESS DESIGN

Dekton® Slim is very simple to install and can be cut with great ease. It is the ideal surface to personalize your bathroom with innovative designs.

04



DEKTON®

# Advantages & Formats

Large format surface with the best market advantages. Discover them.



## Dekton® Advantages



Highly UV Resistant



Scratch Resistant



Stain Resistant



Fire and Heat Resistant



Freezing Resistant



Abrasion Resistant



Superior Mechanical Resistance



Low Water Absorption



Dimensional Stability



Fireproof Material



High Resistance to Hydrolysis

## Ultra Thickness

4 mm\*, 8 mm, 12 mm, 20 mm and 30 mm

## Ultra Size

Up to 126" x 56"

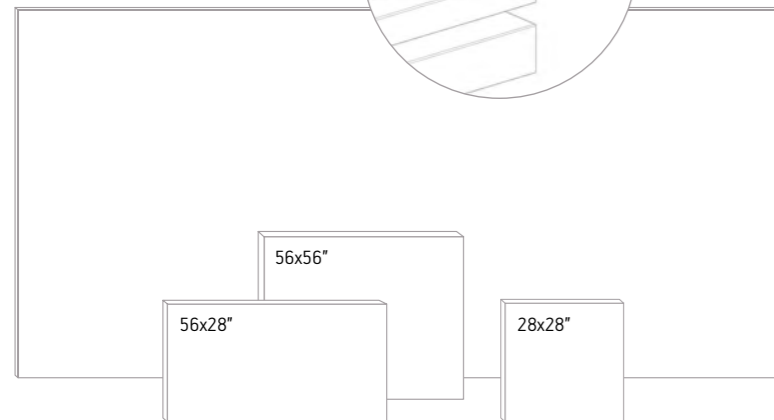

## Dekton® Resists Everything

Extremely resistant to scratching, virtually zero porosity and highly resistant to aggressive chemical products.

## Relentless in Heat

Extreme resistance to high temperatures, cookware fresh off the hotplate and UV rays.

## Unlimited Inspiration

Design your modern kitchen with eye-catching colors and unique textures. Large format for new compositional solutions.

## Countertop to be Enjoyed

Easy maintenance, no traces of fingerprints or marks and maximum durability. Your Dekton worktop is guaranteed for 25 years.

## Infinite Possibilities

Thanks to the size (up to 126" x 56")\* and the lightness of Dekton® (from 8 mm thick), the design possibilities for your kitchen, bathroom, façade, walls or heavily trafficked floors are growing exponentially.

## Dekton® X-Gloss Advantages



Crystalline Shine



Water Repellent

\* The largest size for Zenith, Aura15, Kairos, Entzo, Halo, Tundra, Fiord, Glacier, Nayla and Vienna is 123.5" x 55".

\* 3cm thickness available in selected colors.

\* 4 mm thickness available in selected colors. Available only for some colors and only for floor coverings, walls and furniture. It is not suitable for countertops.

DEKTON®

## Applications

Dekton offers multiple applications for both indoors and outdoors. Facades, countertops, heavily trafficked floors, etc...

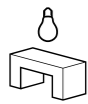

Kitchen countertops



Bathroom countertops

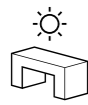

Outdoor countertops

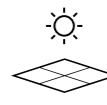

Outdoor Terrace Floor Coverings

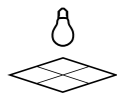

Indoor floors

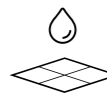

Bathroom and Pool Floor Coverings



Outdoor Terrace Floor Coverings



Bathroom Walls

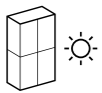

Exterior Walls and Façades

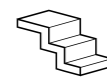

Stairs

## Kitchen Countertops

Dekton® is a long-term product for those looking to turn their kitchen into a unique space.



Dekton® Aura

Dekton is a long-term product for those looking to turn their kitchen into a unique space. It allows installation in one piece with no cuts, no joints, no limits, just the appeal of a completely uniform surface, which fits seamlessly into a variety of different design styles.

Dekton combines the qualities expected by the chef in all of us. It is a clean surface that is nice to the touch, resistant to all the daily grind that takes place in a kitchen over years of use. An ultra- sophisticated

material for busy everyday life, capable of creating spaces that make the preparing food, day after day, a pleasant experience that precedes the pleasure of sharing a meal with friends and family.

It represents beauty and solidity with easy, fuss-free cleaning. The structural density of Dekton is a breakthrough in engineering and it resists scratches, stains and traces of heat.



Dekton® Lunar Industrial Collection



Dekton® Oris  
Industrial Collection

## Outdoor Kitchen Countertop

*Cook with the Sky as your Roof*



Dekton® Zenith

Cooking is definitely a pleasurable experience and doing it outdoors, usually results in a small social event. Everyday celebrations that we can enjoy with company around a grill. Dekton®, due to its ultra-compact structure, is particularly suitable for installations for outdoor kitchens and barbeques.

Dekton® provides strength and style to these spaces, it gives them an undeniable personality and unlimited practicality. Stains, bumps, utensils at high temperature... Dekton® will resist the demanding use over time while maintaining its unchanging beauty.

It is not affected by ice, sun, sleet, or wind either. When bad weather arrives, Dekton® simply needs an effortless, fuss-free cleaning so that it can showcase its best again.

# Bathroom Countertops and Wall Covering

The bathroom is the space in the home, where hygiene and harmony need to express themselves in the best possible way. A peaceful environment devoted to personal care and hygiene - a space to relax and unwind free of any worries.

Dekton®, thanks to its low porosity, is completely waterproof against liquids.

Water glides smoothly without ever penetrating the surface. This, along with unchanging beauty, results in extremely easy cleaning.

Their textures and colors are an endless source of inspiration for the design of water-related areas, we're talking about Dekton®, its possibilities are endless.



Cladding - Dekton® Soke Industrial Collection / Flooring - Dekton® Halo Xgloss Solid Collection



Dekton® Arga  
X-Gloss Stonika

# Façades

Dekton is available in large format panels with minimum thickness, rewriting the rules of what is possible with Ultracompact Surfacing materials. Dekton panels measure 56" x 126" with a thickness range of 8mm to 30mm. Aside from the advantage of its size capabilities, DEKTON is highly resilient and can be installed as part of ventilated rainscreen system, or, due to its

remarkable durability and low moisture absorption, installed as a direct adhere façade, similar to dimensional stones like granite.

DEKTON is the architect's choice when unlimited surface and space designs are required, where color and texture flow freely in all directions inside and out, expressing itself in all of its fullness and versatility.

## ***High Performance All Purpose Façades Designing Without Limits***

Large Format Panels: 56" x 126"  
Thickness: 0.31" , 0.47" and 0.79"  
Flexural strength  
Excellent dimensional stability  
Resistance to freezing and thawing  
Unmatched Color stability



# Flooring Solutions

DEKTON Ultra-Compact Tile for Floor & Wall coverings are a universal architectural application material that is better than porcelain for both indoors and outdoors. The revolutionary DEKTON properties allow Architects & Designers

total freedom to design for any application and project. With a variety of sizes and thicknesses, DEKTON is the perfect fit for any project that is considering Large Format Tile!



## Dekton Flooring Advantages

Dekton has gone through 3rd party TCNA Standards according to ASTM testing methods and in the most important areas of value, exceeds the standards and test results of porcelain tile! When you compare the results in breaking strength (Flexural) or breaking strength (Point Load) or flatness, abrasion resistance, scratching, staining and UV ray resistance, DEKTON is an almost indestructible product!

## A Solutions for Stairs

Stairs can be a challenge for the architects and designers that want to cover them with a material that can be adapted to any space, Dekton, provides the perfect solution and versatility. Dekton stairs can be presented as raised stairs or traditional stairs because of the different thicknesses, 8mm, 12mm, 20mm or 30mm, allowing you to provide the best application for the most demanding people.

## Unlimited Sizes

As a value unmatched by other large format products, DEKTON offers a variety of sizes and thicknesses. From standard nominal sizes of 28"x 28", 56"x 56", 56"x 28" or 62"x 28" 41"x 28", 56" x 41", 56" x 62" and 56" x 31".

## Aura Bookmatch

*With Aura we have evolved from a single slab design to an endless symmetrical pattern. With 8 unique designs, we can reproduce matching compositions that allow continuous vein matching from slab to slab.*

THERE ARE 2 POSSIBLE WAYS TO ORDER AURA:

**Regular Aura slabs.** You will receive a random pattern and the slabs are available in our warehouse.

**Book and Vein matched Aura slabs.** These slabs are available on demand and will be inventoried at our HUB facilities. Vein and book matched materials will be charged at an additional fee.

Aura is matched vertically and horizontally; we have a system with letters and numbers so you can select the pattern that better fits your needs. Notice that you can choose different combinations depending on the amount of vein you like in your design. You may also choice from vertical or horizontal matching as well as traditional mirror bookmatching effect or vein matching.



DEKTON®

# Color Chart

Discover the color that fits your idea or project.



Antislip treatment is only recommended for barefoot areas, such as pool or spas. This treatment can produce a slight variation in the color tone. \*Size up to 126" x 56"

- ULTRA TEXTURE
- ULTRA MATTE
- VELVET TEXTURE
- XGLOSS

- RECYCLED CONTENT
- THICKNESS 3CM
- THICKNESS 4CM
- DEKTON GRIP  
The anti-slip solution

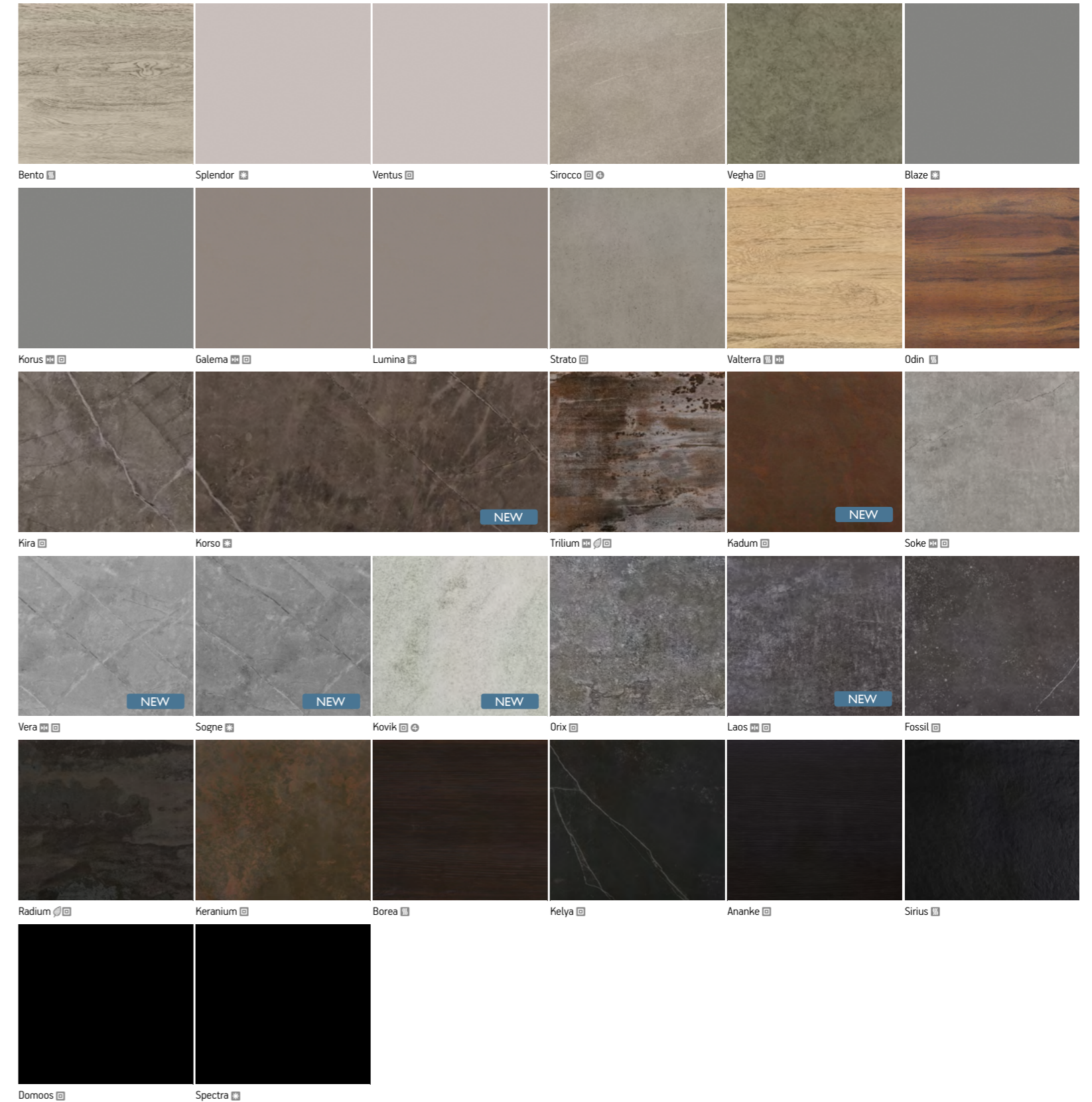

# Ultracompact Surfaces - Available Colors

	COLOR NAME	COLLECTION			COLOR NAME	COLLECTION	
GROUP 0	AGED TIMBER	WILD COLLECTION	☰	GROUP 3	AURA 15	NATURAL COLLECTION	☐
	ALDEM	WILD COLLECTION	☰		BLAZE	XGLOSS-SOLID COLLECTION	✳
	BEDROCK	NATURAL COLLECTION	☐		ENTZO	NATURAL COLLECTION	☐
	BLANC CONCRETE	TECH COLLECTION	☐ 🚚		FIORD	XGLOSS-NATURAL COLLECTION	✳
	GADA	NATURAL COLLECTION	☰		GLACIER	XGLOSS-NATURAL COLLECTION	✳
	ODIN	WILD COLLECTION	☰		KAIROS	NATURAL COLLECTION	☐
	SAND DRIFT	NATURAL COLLECTION	☐		KORSO <b>NEW!</b>	XGLOSS-STONIKA COLLECTION	✳
	SIROCCO	NATURAL COLLECTION	☐ 4		LUMINA	XGLOSS-SOLID COLLECTION	✳
	STERLING	NATURAL COLLECTION	☐		OPERA	NATURAL COLLECTION	☐ 4
	VAPOUR	NATURAL COLLECTION	☐		PORTUM <b>NEW!</b>	NATURAL COLLECTION	☐
	VEGHA	NATURAL COLLECTION	☐		SOGNE <b>NEW!</b>	XGLOSS-STONIKA COLLECTION	✳
	GROUP 1	DANAE	NATURAL COLLECTION		☐ 🚚	SPLENDOR	XGLOSS-SOLID COLLECTION
EDORA		NATURAL COLLECTION	☰	TUNDRA	XGLOSS-NATURAL COLLECTION	✳	
FOSSIL		NATURAL COLLECTION	☐	ZENITH	SOLID COLLECTION	☐ 🚚 4	
KEON		TECH COLLECTION	☐ 🚚	GROUP 4	ARGA <b>NEW!</b>	XGLOSS-STONIKA COLLECTION	✳
KERANIUM		TECH COLLECTION	☐ 🚚		AURA 15 BOOKMATCH	NATURAL COLLECTION	☐
NAYLA		NATURAL COLLECTION	☐ 4		BERGEN <b>NEW!</b>	XGLOSS-STONIKA COLLECTION	✳
SASEA <b>COMING SOON!</b>	NATURAL COLLECTION	☐ 4	HALO		XGLOSS-SOLID COLLECTION	✳	
SIRIUS	SOLID COLLECTION	☰	NATURA 18		XGLOSS-NATURAL COLLECTION	✳	
DOMOOS	SOLID COLLECTION	☐ 🚚	OLIMPO <b>NEW!</b>		XGLOSS-STONIKA COLLECTION	✳	
GROUP 2	GALEMA	SOLID COLLECTION	☐	SPECTRA	XGLOSS-SOLID COLLECTION	✳	
	KELYA	NATURAL COLLECTION	☐ 4	TAGA <b>NEW!</b>	XGLOSS-STONIKA COLLECTION	✳	
	KIRA <b>NEW!</b>	NATURAL COLLECTION	☐				
	KORUS	SOLID COLLECTION	☐				
	KOVIK <b>COMING SOON!</b>	NATURAL COLLECTION	☐ 4				
	LAOS <b>NEW!</b>	INDUSTRIAL COLLECTION	☐				
	LUNAR <b>NEW!</b>	INDUSTRIAL COLLECTION	☐				
	MAKAI	WILD COLLECTION	☰				
	NILIUM	INDUSTRIAL COLLECTION	☐				
	ORIX	INDUSTRIAL COLLECTION	☐				
	RADIUM	INDUSTRIAL COLLECTION	☐				
	SOKE <b>NEW!</b>	INDUSTRIAL COLLECTION	☐				
	STRATO	TECH COLLECTION	☐				
	TRILIUM	INDUSTRIAL COLLECTION	☐				
VENTUS	SOLID COLLECTION	☐					
VERA <b>NEW!</b>	NATURAL COLLECTION	☐					
VIENNA	XGLOSS-BASIQ COLLECTION	✳					

Normal sizes: 56" x 126".

✳ Polish ☐ Smooth mate finish ☰ Textured finish ☐ Velvet

🚚 TILE SIZES QUICKSHIP 4 Thickness 4cm

☐ Dekton Grip + is recommended only for flooring with special slip-resistance requirements. To know the colours available with this treatment, ask your nearest Cosentino Centre.

The thickness 4mm is served in units of 10 or 25 slabs. The material will be served from Cosentino Central HQ, see delivery terms.  
Dekton Slim, 4mm is only recommended for furniture and interior cladding.



Dekton® Bergen Xgloss Stonika





SENSA BY COSENTINO®

## Protected Natural Stone

*Sensa is a maintenance free premium Natural Stone brought to you by Cosentino, a world leader in the natural stone industry.*

Sensa is a granite surface by Cosentino, a high-quality surface that offers such reliable performance that it comes with a 15-year certified guarantee. We travelled all the way to Brazil and India to find the most beautiful stone that nature can create. This stone was chosen following strict criteria of aesthetic excellence that resulted in unique, elegant surfaces with an exotic, yet subtle, touch. Unique. The adjective is well-chosen. Every Sensa slab is different from the rest because each surface has exceptional veining that is found in no other. A product idea for demanding customers who require a material that is resistant to scratches and stains and that offers outstanding performance over time.



Sensa® Gabana Leather

SENSA BY COSENTINO®

# Advantages

Sensa Protected Natural Stone with SenGuard™ Adds Elegant Style To Your Kitchen with Long-Term Stain Protection.



100% Stain protection with SenGuard technology.



Does not require sealers or specialized cleaners.



Maintenance-free Premium Natural Stone.



UV resistant - Sustainable for Outdoor Applications.



15-year Transferable Warranty.



Withstands Temperatures of up to 5720 F (3000 c).

Sensa by Cosentino® consists of maintenance-free, high-quality, natural granite offered by Cosentino, a global leader in the natural stone industry for more than 80 years. Sensa by Cosentino® has a revolutionary protective treatment that provides high stain resistance and has a 15-year transferable warranty. You will discover that Sensa by Cosentino® offers you a range of colors to combine with any décor scheme or project. A protective treatment is applied to each slab of Sensa by Cosentino® in Cosentino's modern facilities. This protective treatment has a 15-year transferable warranty that will allow you to continue to enjoy the natural beauty of your Sensa by Cosentino® countertop for a long time. With Sensa by Cosentino®, you will add an elegant touch to your kitchen and will be highly protected against common household stains.



Sensa® Crescent Veil

SENSA BY COSENTINO®

# SenGuard Protection

SenGuard is a proprietary stone treatment that is used to protect Sensa granite from staining. SenGuard is not a sealer, it bonds to the granite surface like no other sealers can.

The SenGuard treatment, unlike common sealers, allows the stone to breathe by anchoring to the stone lattice while preserving the stone's natural, beautiful color for years to come.

- No sealing required.
- Enters stone lattice and chemically bonds, allowing stone to breathe.
- No special cleaners required. Common household cleaners do not affect the SenGuard protection.
- SenGuard remains bonded to stone.
- Proprietary treatment applied in state-of-the-art controlled environment facility.



SENSA  
by COSENTINO®

REGULAR

# Unique Exclusive Design

Works of art that have required millennia to finish are now part of the finest collection in the world.

Cosentino's experts selected these natural stone paintings one by one to bring them from the other end of the globe to the most elegant, personal and exclusive museum: your home.

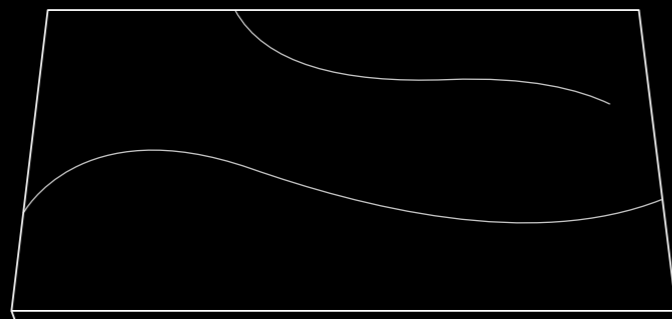
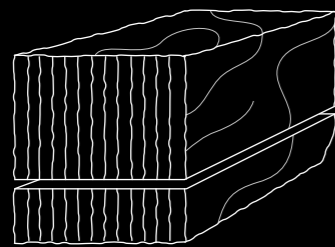
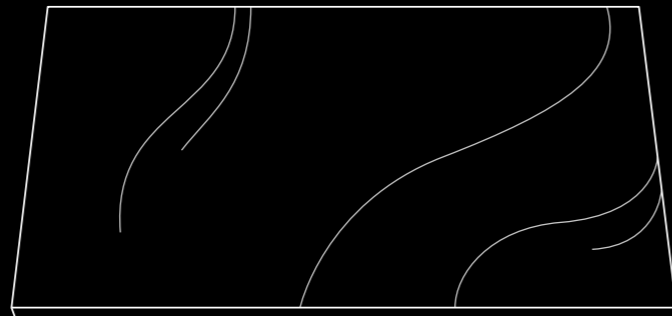
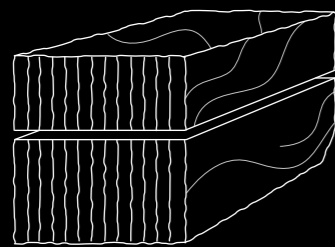
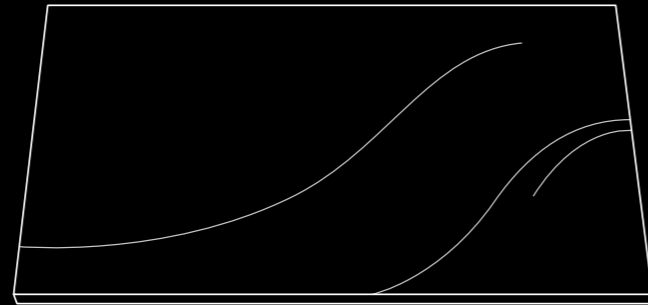
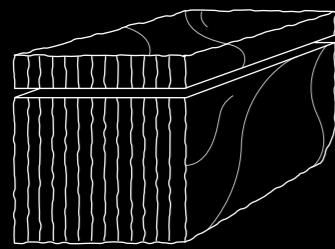

Sensa® Taj Mahal

SENSA BY COSENTINO®

# Color Chart

*Natural colors brought directly from nature.*

-  POLISHED
-  LEATHER
-  CARESSE





Gabana 

Taj Mahal 

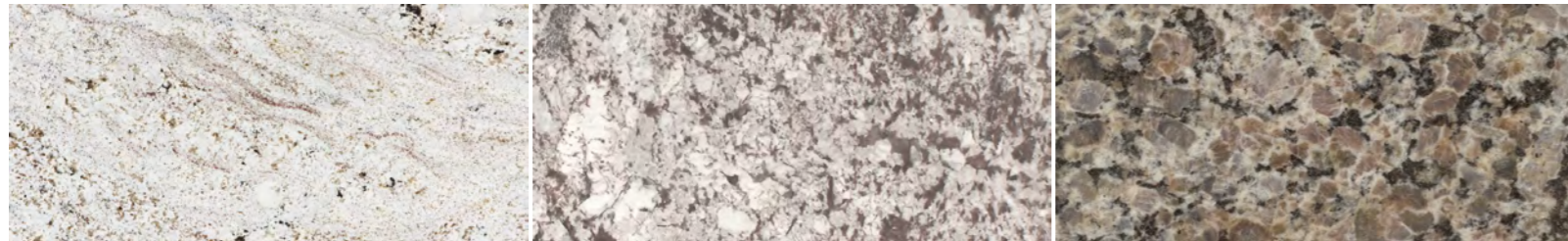
Tangjer 





Blanco Gabrielle 

White Splendor 

Caledonia 





Brown Persa 

Caroline Summer 

Crema Pearl 





Crescent Veil 

Delicatus Ice 

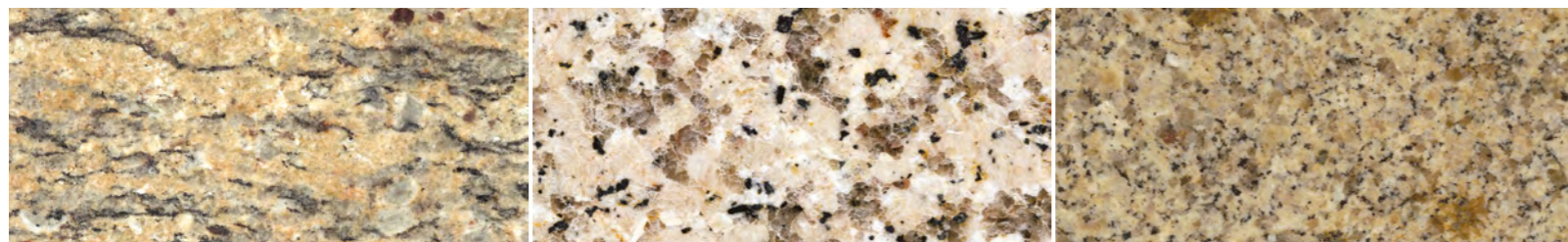
Giallo Latina 



Golden King 

Iberian Sunset 

Juparana Cathedral 

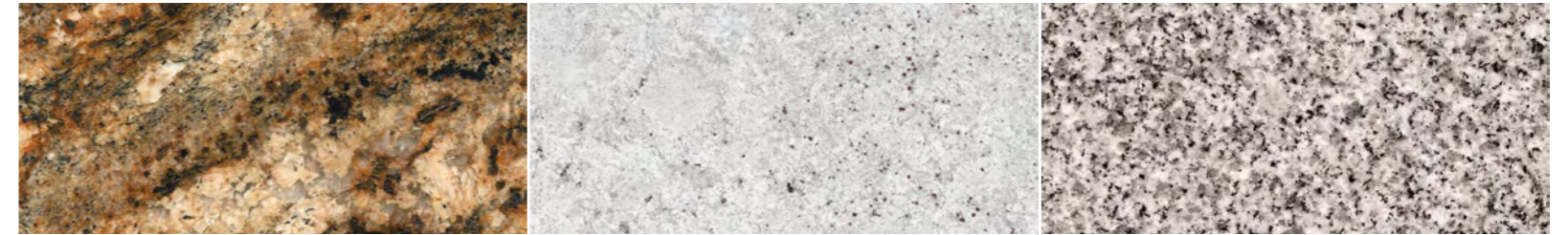

Lapidus 

Madison Spring 

Majestic White 

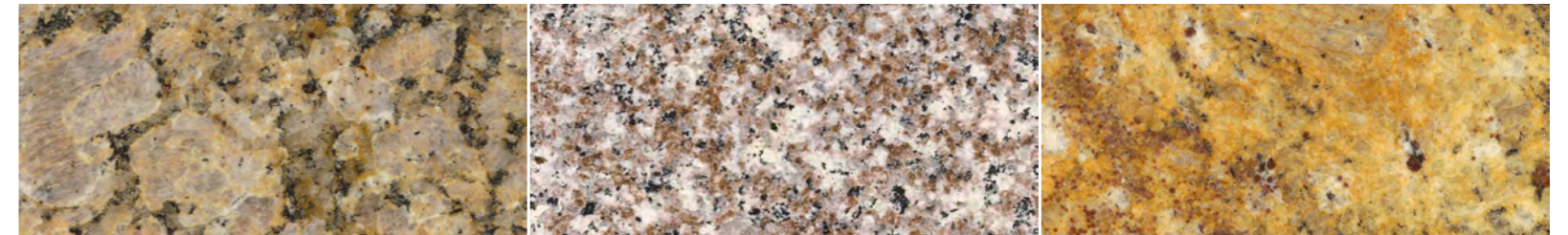



Outono 

Red Terrain 

Santa Cecilia 





Silver Silk 

Star Beach 

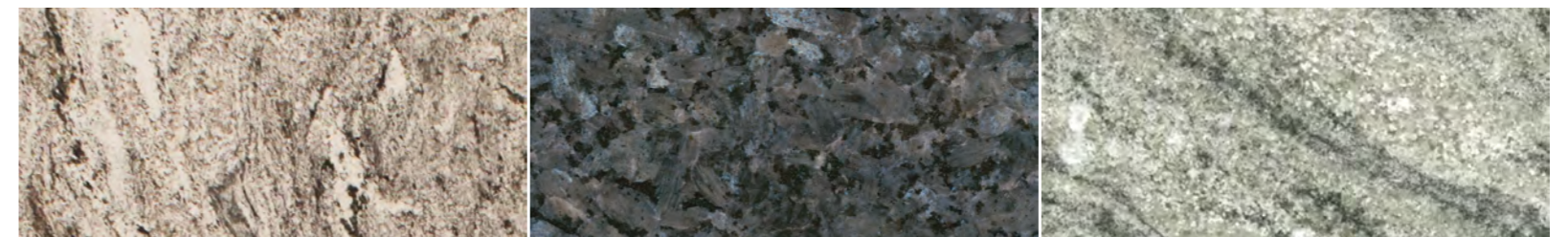
Tanami 





Waterfall 

Blue Pearl 

Verde Aquarius 



Dawn Mist 

Snowfall 

White Egeo 

SENSA BY COSENTINO®

# Color Chart

-  POLISHED
-  LEATHER
-  CARESSE

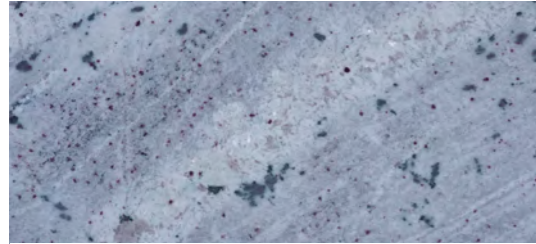

White Moon 



White Macaubas 

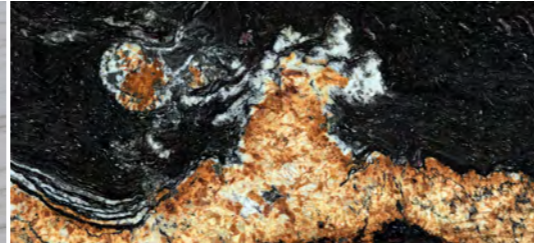

Orinoco 

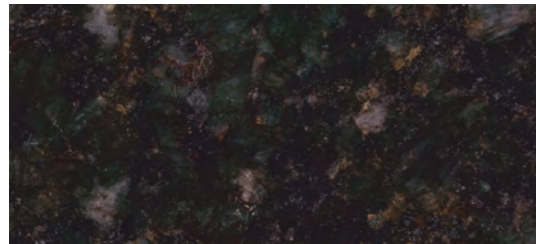

Ubatuba 

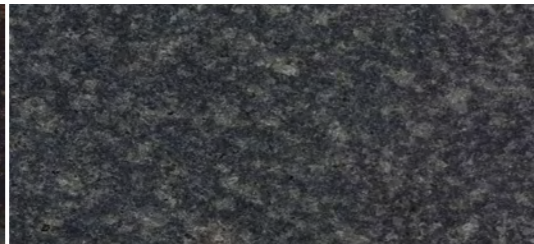

Graphite Grey 

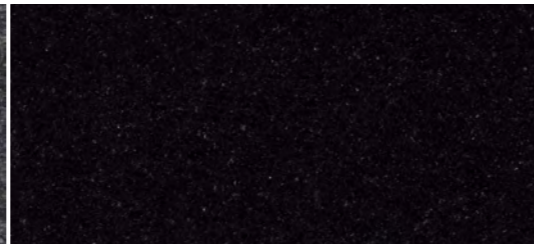

San Benedito 



Amelia Ridge 

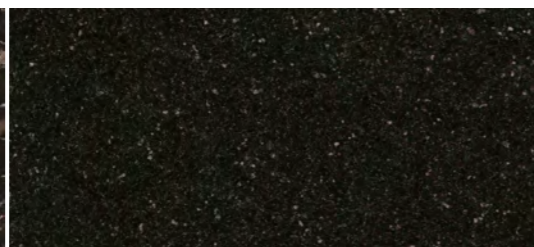

Black Galaxy 

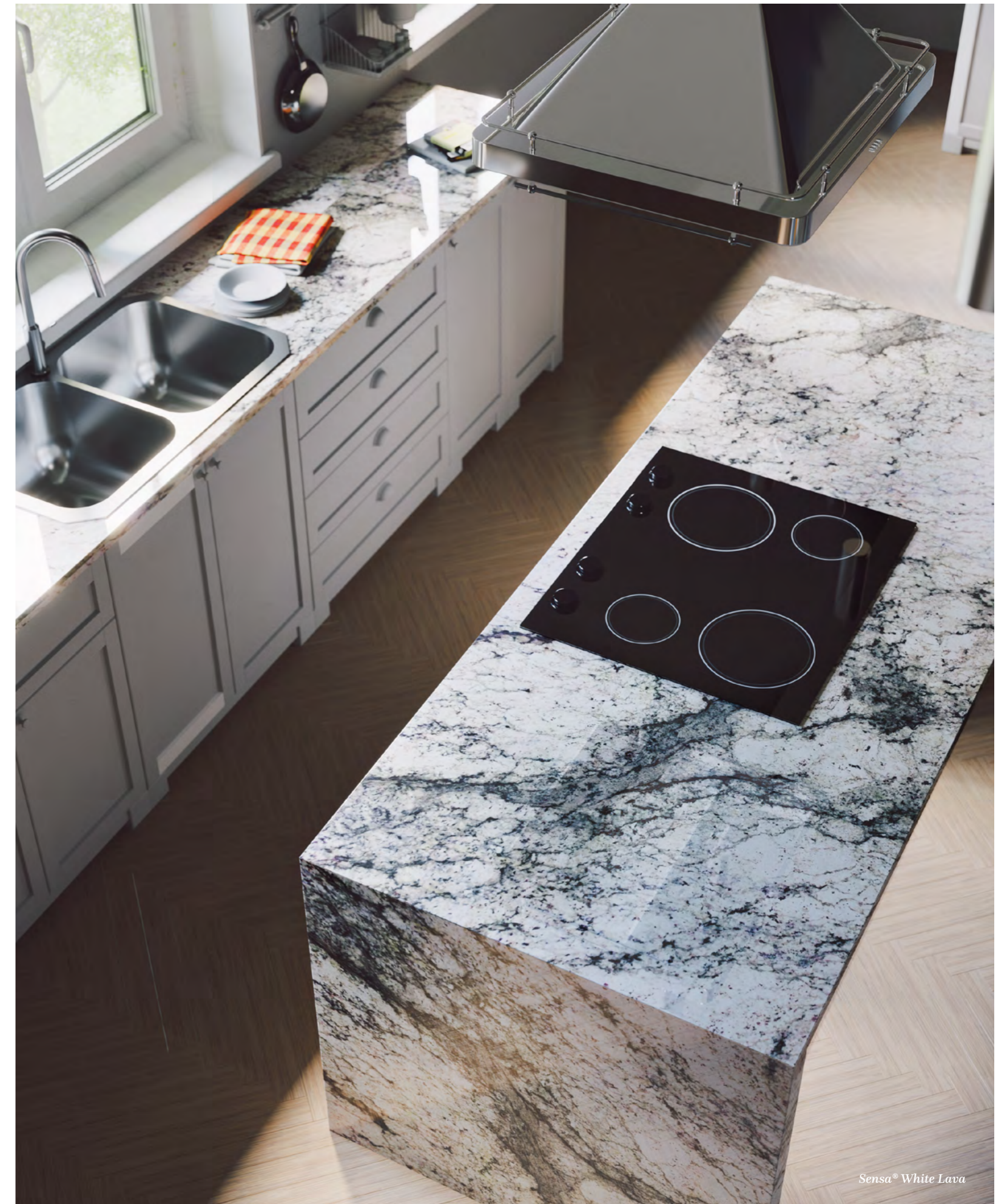

Sensa® White Lava

COSENTINO®

## Scalea Natural Stone

*Cosentino is identified with the latest trends in décor and style in Natural Stone.*

The different collections of local and imported marble and slate, Brazilian granite and travertine offers a wide variety of solutions for decorating or covering any space.

Ideal solutions for both public and private spaces that respond to the most current and demanding decorative and architectural needs. But Cosentino Natural Stone is not only a practical solution. Is a Natural stone in a pure state.



Scalea®  
White Macaubas

# Color Chart

*The best color range for the most varied and complex projects.*

-  POLISHED
-  LEATHER
-  CARESSE



Blanco Gabrielle 

Colonial White 

Santana 





Azul Platino 

River White 

White Macaubas 



Venato Carrara 

Soapstone Barroca 

Soapstone Fantasy 

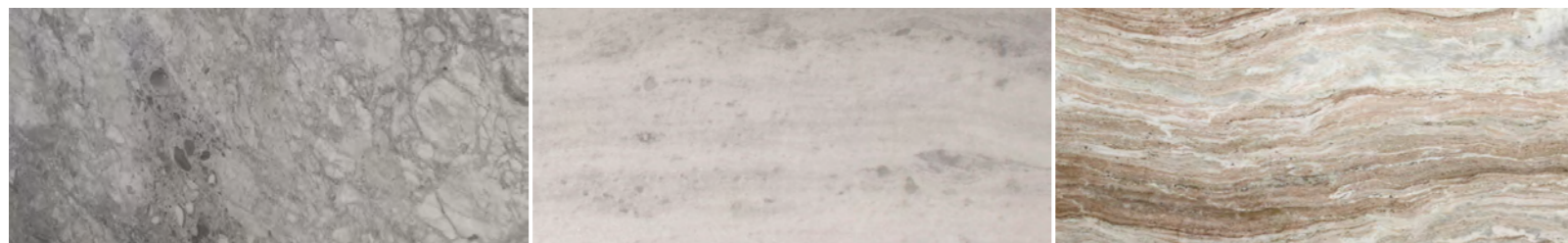



Arabescato A2 

Blanco Cachoeiro 

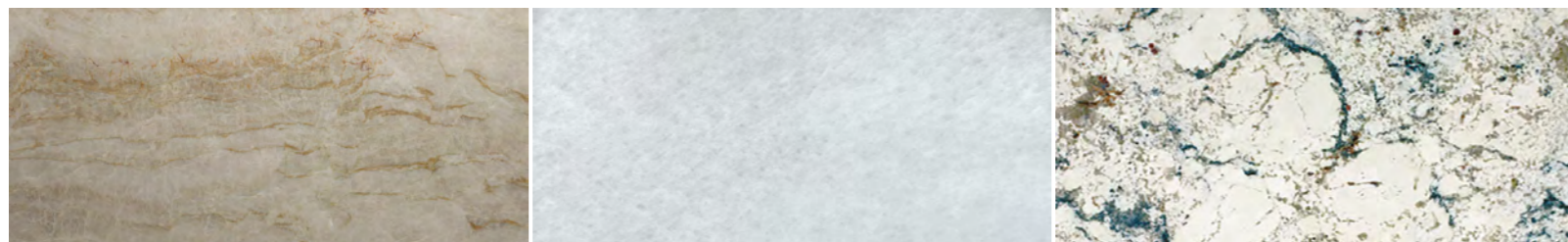
Fantasy Brown 





Taj Mahal 

Alaskan White 

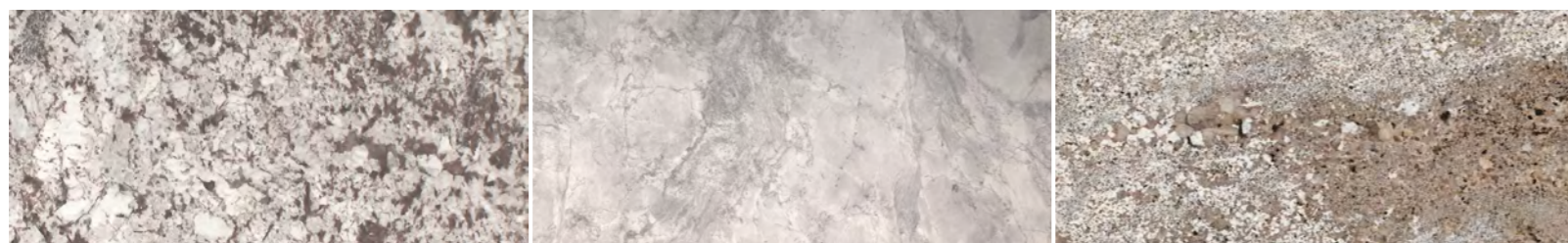
White Ice 





White Splendor 

Arabescato A1 

Bianco Antico 





Crema Marfil 

Brown Persa 

Blanco Leblon 





Caroline Summer 

Juparana Gold 

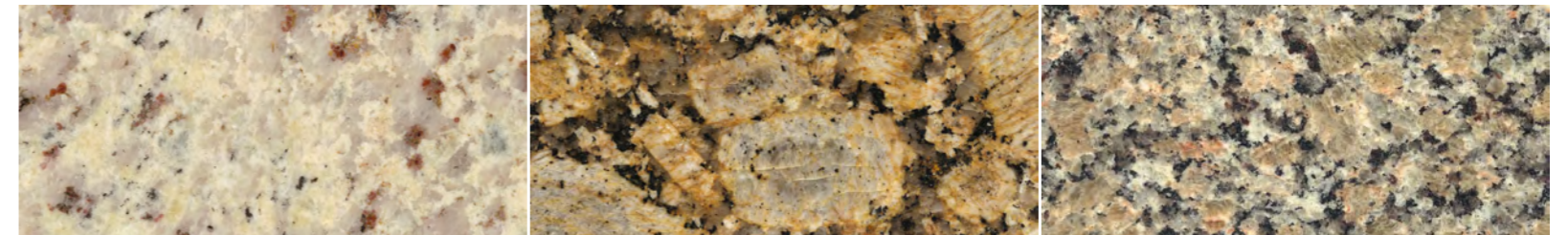
Crema Bordeaux 





Crema Pearl 

Giallo Fiorito 

Giallo Latina 





<Sin datos de vínculo> 

Ornamental Light 

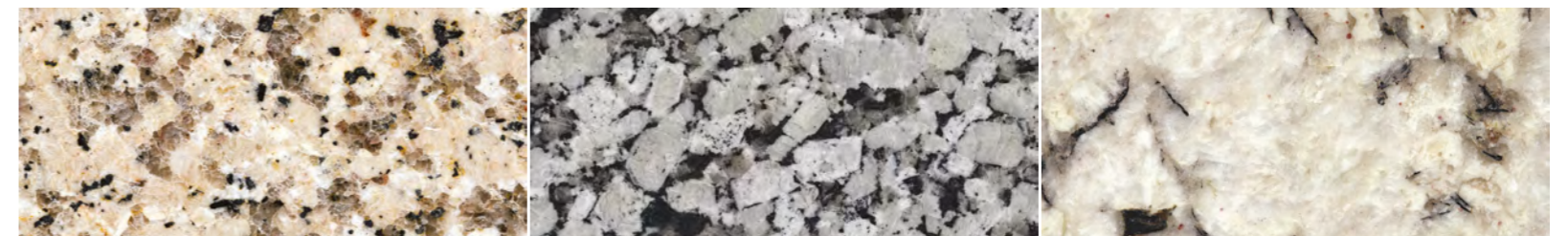
Golden King 





Iberian Sunset 

Iberian White 

Ice Blue 



Javea Cream 

Juparama Dream 

Lapidus Gold 

# Color Chart

-  POLISHED
-  LEATHER
-  CARESSE

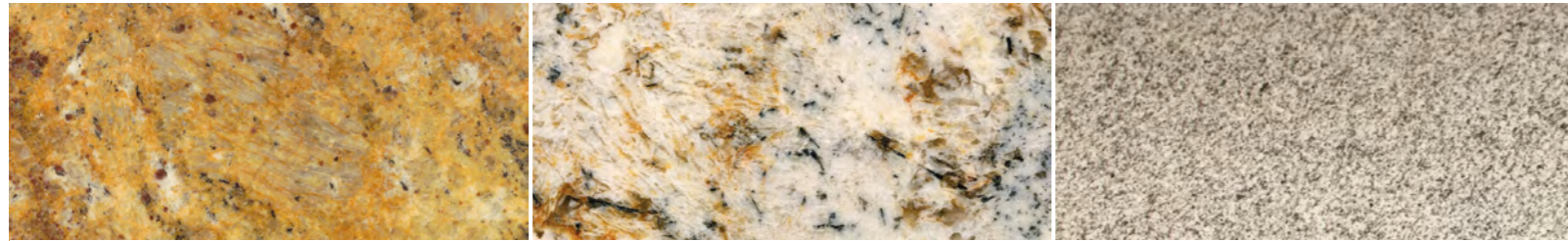

Santa Cecilia 

Star Beach 

Luna Pearl 





Majestic White 

New Caledonia 

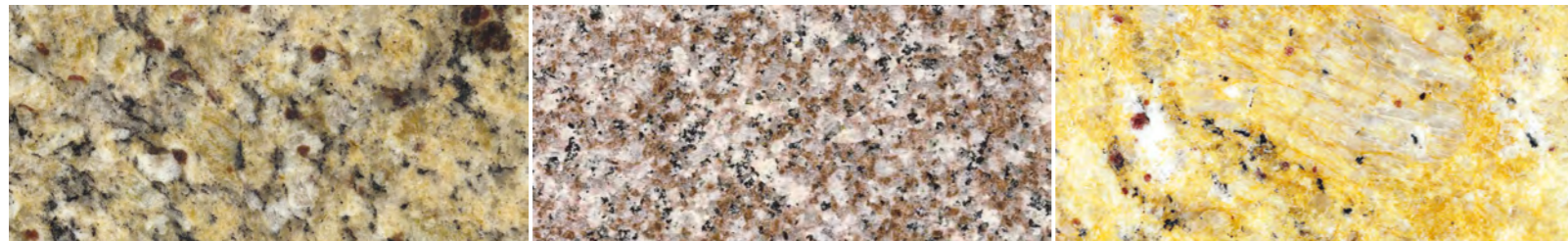
New Venetian Gold 





Oro Brazil 

Red Terrain 

Santa Cecilia Light 





Star White 

Typhoon Bordeaux 

Waterfall 





White Bahia 

Negro San Gabriel 

Ubatuba 



Floresta Green 

Coffee Brown 

Kozmus 





Negro Indiano 

Cygnus Granite 

Marron Emperador 





Tropical Brown 

Tan Brown 

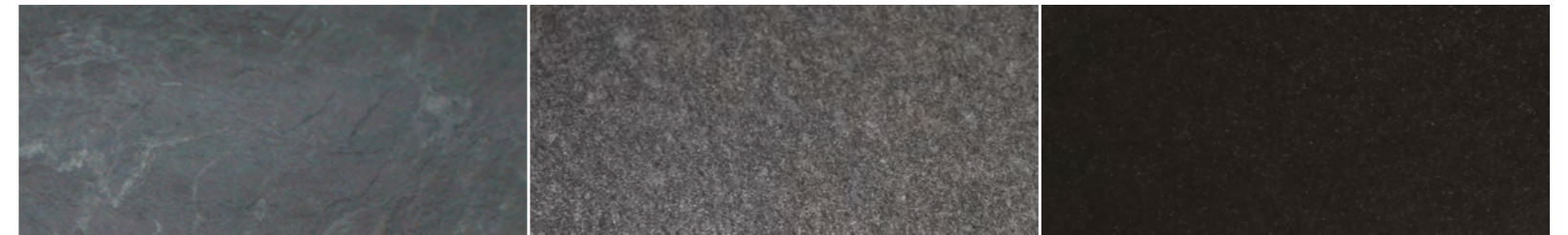
Soapstone Black Pencil 





Soapstone Julia 

Steel Grey 

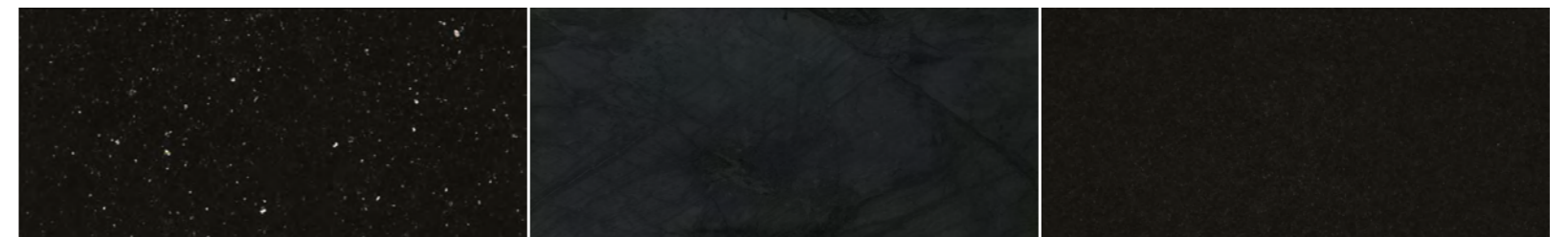
Black Pearl 



Star Galaxy 

Soapstone Fumaça 

Negro Absoluto 



COSENTINO®

# Prexury Semi-Precious Stone

*The semi-precious stones used in Prexury come from all over the world.*

Each piece has an authentic semi-precious stone certificate that identifies and enable the consumer to trace the product.

PREXURY BY COSENTINO®

## Color Chart

*Cosentino brings material traditionally used in jewelry.*



Prexury® Carnelian



Prexury® Smokey Quartz



Classic Quartz

Rose Quartz

Smokey Quartz



Carnelian

Petrified Wood

Amethyst



Angel Jasper

Wild Agate

Red Jasper



Retro Petrified Wood

Retro Tiger Iron

Labradorite

## Showroom Centers - United States

1. **ANAHEIM**  
611 E. Cerritos Avenue  
Anaheim, CA 92805  
Phone: 714.520.4100  
Fax: 714.520.4329
2. **ATLANTA**  
1741 Wilwat Drive - Bldg. B  
Norcross, GA 30093  
Phone: 770.409.9621  
Fax: 404.478.9578
3. **AUSTIN**  
1340 Airport Commerce Dr.  
Suite 100  
Austin, TX 78741  
Phone: 512.386.7791  
Fax: 877.582.6531
4. **BOSTON**  
120 Shawmut Road  
Canton, MA 02021  
Phone: 508.393.9600  
Fax: 508.393.9611
5. **CHARLOTTE**  
11435 Granite Street - Suite B  
Charlotte, NC 28273  
Phone: 704.504.1538  
Fax: 704.315.5353
6. **CHICAGO**  
1060 W. Division Street - Bldg. B  
Chicago, IL 60642  
Phone: 312.649.4045  
Fax: 312.944.0134
7. **CINCINNATI**  
4260 Port Union Road - Suite 200  
Fairfield, OH 45011  
Phone: 513.942.0015  
Fax: 513.214.2535
8. **DALLAS**  
11639 Emerald Street - Suite 400  
Dallas, TX 75229  
Phone: 214.256.9700  
Fax: 214.256.9800
9. **DENVER**  
12435 E. 42nd Ave - Suite 50  
Denver, CO 80239  
Phone: 303.895.3450  
Fax: 303.895.2298
10. **DETROIT**  
17608 Commerce Dr.  
New Boston, MI 48164  
Phone: 734.844.9990  
Fax: 734.844.9991
11. **FORT LAUDERDALE**  
3000 SW 42nd St.  
Fort Lauderdale, FL 33312  
Phone: 305.398.5700  
Fax: 305.398.5705
12. **HAMPTON – VIRTUAL CENTER**  
2355 Aluminum Avenue - Bldg. A  
Hampton, VA 23661  
Phone: 757.838.4769  
Fax: 757.941.5536  
Email: gregg@cosentino.com
13. **HAWAII**  
2678 Kilihou Street  
Honolulu, HI 96819  
Phone: 808.427.5192
14. **HOUSTON**  
1315 W. Sam Houston Pkwy N.  
Suite 150  
Houston, TX 77043  
Phone: 281.207.4500  
Fax: 281.582.3514
15. **KANSAS CITY**  
15403 W. 100th Terrace  
Lenexa, KS 66219  
Phone: 913.888.0935  
Fax: 913.827.1766
16. **LONG ISLAND**  
35 Engel Street  
Hicksville, NY 11801  
Phone: 516.822.4521  
Fax: 516.704.2454
17. **LOS ANGELES**  
12822 Rangoon St.  
Los Angeles, CA 91331  
Phone: 818.381.8220
- NEW** 18. **COSENTINO CITY LOS ANGELES**  
8764 Beverly Blvd.  
West Hollywood, CA 90048
19. **COSENTINO CITY MANHATTAN**  
150 E. 58th St. #399  
New York, NY 10155  
Phone: 646.891.3653  
Fax: 212.881.9507
20. **COSENTINO CITY MIAMI**  
3898 Biscayne Boulevard  
Miami, FL 33137  
Phone: 305.571.7285
21. **MILWAUKEE**  
S64W15680 Commerce Center  
Pkwy, Suite A  
Muskego, WI 53150  
Phone: 414.422.0085
22. **MINNEAPOLIS**  
14105 13th Avenue North - Suite 2  
Minneapolis, MN 55441  
Phone: 763.546.8456  
Fax: 708.221.6021
23. **NASHVILLE**  
1421 Gould Blvd - Suite B  
Laverne, TN 37086  
Phone: 615.722.0067
24. **NEW JERSEY**  
55 Passaic Ave.  
Fairfield, NJ 07004  
Phone: 973.487.1364
25. **NEW ORLEANS**  
5800 Jefferson Hwy., Suite C & D  
Elmwood, LA 70123  
Phone: 504.410.3116
26. **ORLANDO**  
4420 N. Orange Blossom Trail  
Orlando, FL 32804  
Phone: 407.298.8083  
Fax: 407.218.5207
27. **PHILADELPHIA**  
121 Green Tree Road, Unit 3  
Oaks, PA 19456  
Phone: 610.666.1328  
Fax: 610.628.3007
28. **PHOENIX**  
8307 South Priest Drive  
Tempe, AZ 85284  
Phone: 480.763.9400  
Fax: 480.763.9410
29. **PITTSBURGH**  
104 Tri County Drive #6  
Freedom, PA 15042  
Phone: 724.774.1480
30. **PORTLAND**  
20900 SW 115th Ave., Suite 100  
Tualatin, OR 97062  
Phone: 503.486.6281  
Fax: 503.395.2970
31. **PUERTO RICO**  
La Cerámica Industrial Park  
Calle Gildita, Lote 1-A  
Carolina, PR 00983  
Phone: 305.398.5700  
Fax: 305.398.5705
32. **RALEIGH**  
221 S. Rogers Lane  
Raleigh, NC 27610  
Phone: 919.231.8941
33. **ROCHESTER**  
225 Mile Crossing Blvd.  
Rochester, NY 14624  
Phone: 585.247.2721  
Fax: 585.672.6744
34. **SACRAMENTO**  
10015 Foothills Blvd., Suite 150  
Roseville, CA 95747  
Phone: 916.783.0435
- NEW** 35. **SALT LAKE CITY**  
1650 South Distribution Drive - Suite 400  
Salt Lake City, UT 84104  
Phone: 801.396.7855
36. **SAN DIEGO**  
9020 Activity Road - Suite C  
San Diego, CA 92126  
Phone: 858.653.0225  
Fax: 760.990.5852
37. **SAN FRANCISCO**  
33458 Central Avenue  
Union City, CA 94587  
Phone: 650.872.2132  
Fax: 415.592.3705
38. **COSENTINO CITY SAN FRANCISCO**  
101 Henry Adams Street  
Showroom No. 130  
San Francisco, CA 94103  
Phone: 415.355.9639

## Showroom Centers - Canada

46. **CALGARY**  
10301 19th Street N.E. Unit 101  
Calgary, AB T3J 0R1  
Phone: 587.538.8301
47. **COSENTINO CITY MONTRÉAL**  
240 Rue Saint-Jacques Ouest, Suite 110  
Montreal, QC H2Y 1L9  
Phone: 514.335.8669
48. **QUEBEC**  
240 Chemin des Ursulines  
Stanstead, QC J0B 3E0  
Phone: 819.876.2123  
Fax: 819.876.5380
49. **TORONTO**  
80 Kincort Street  
Toronto, ON M6M 5G1  
Phone: 647.350.6009  
Fax: 647.340.5380
50. **COSENTINO CITY TORONTO**  
665 Caledonia Road  
Toronto, ON M6E 4V8  
Phone: 416.247.9090
51. **VANCOUVER**  
8603 Glenlyon Parkway  
Burnaby, BC V5J 0H6  
Phone: 778.508.9867  
Fax: 844.247.0734

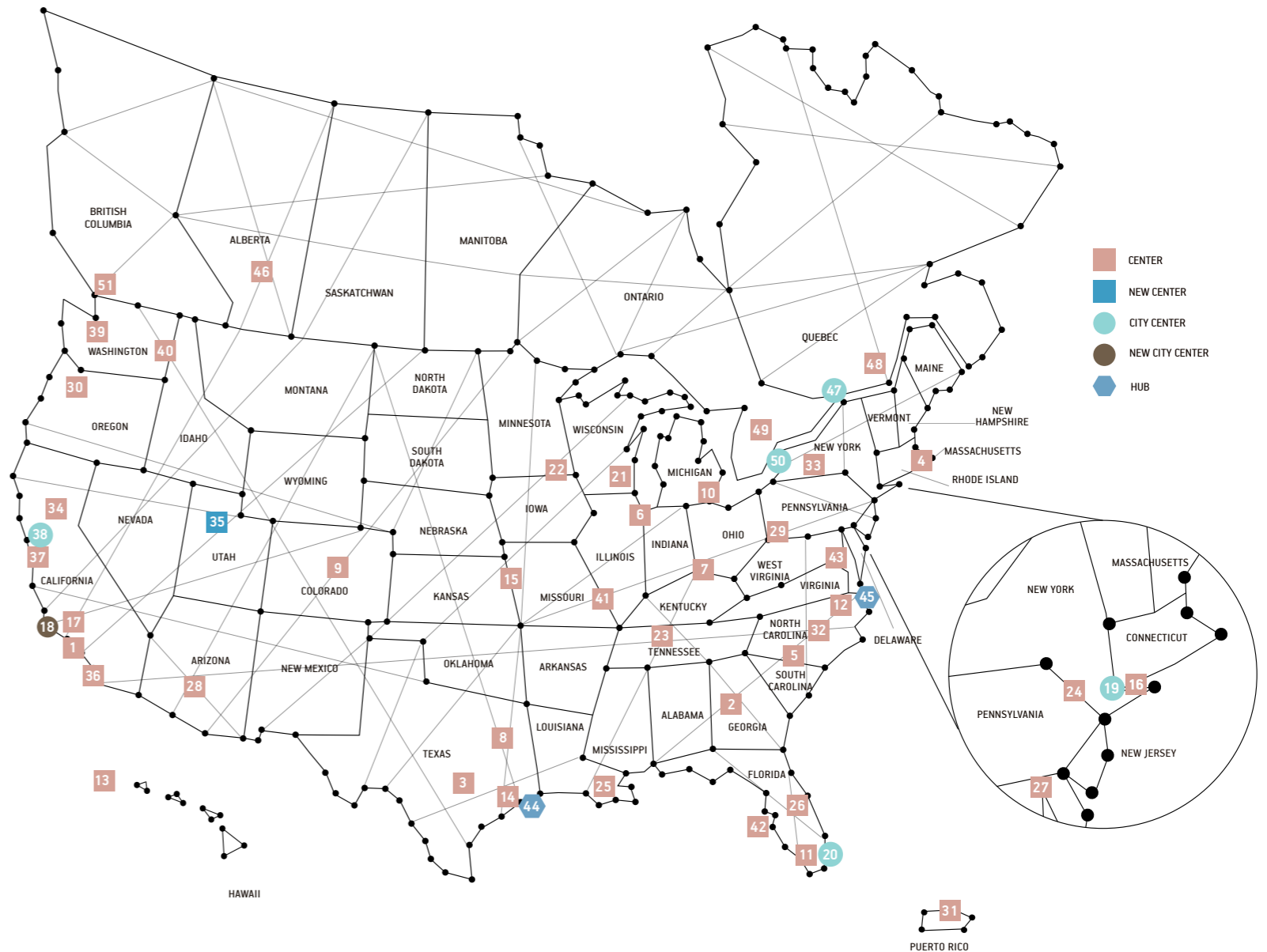





\* See specific warranty conditions.

\*\* To obtain more information about hues with NSF certificate, please visit [www.nsf.org](http://www.nsf.org)

\*\*\*Colors on this brochure are indicative. Please refer to real samples or slabs.

A product designed by **COSENTINO**

COSENTINO NORTH AMERICA HEADQUARTERS  
355 Alhambra Circle Suite 1000,  
Coral Gables, FL 33134 , United States of America  
786.686.5060

   @CosentinoUSA

[www.cosentino.com](http://www.cosentino.com)